

IKARIE

TWIN AUTO FILTER

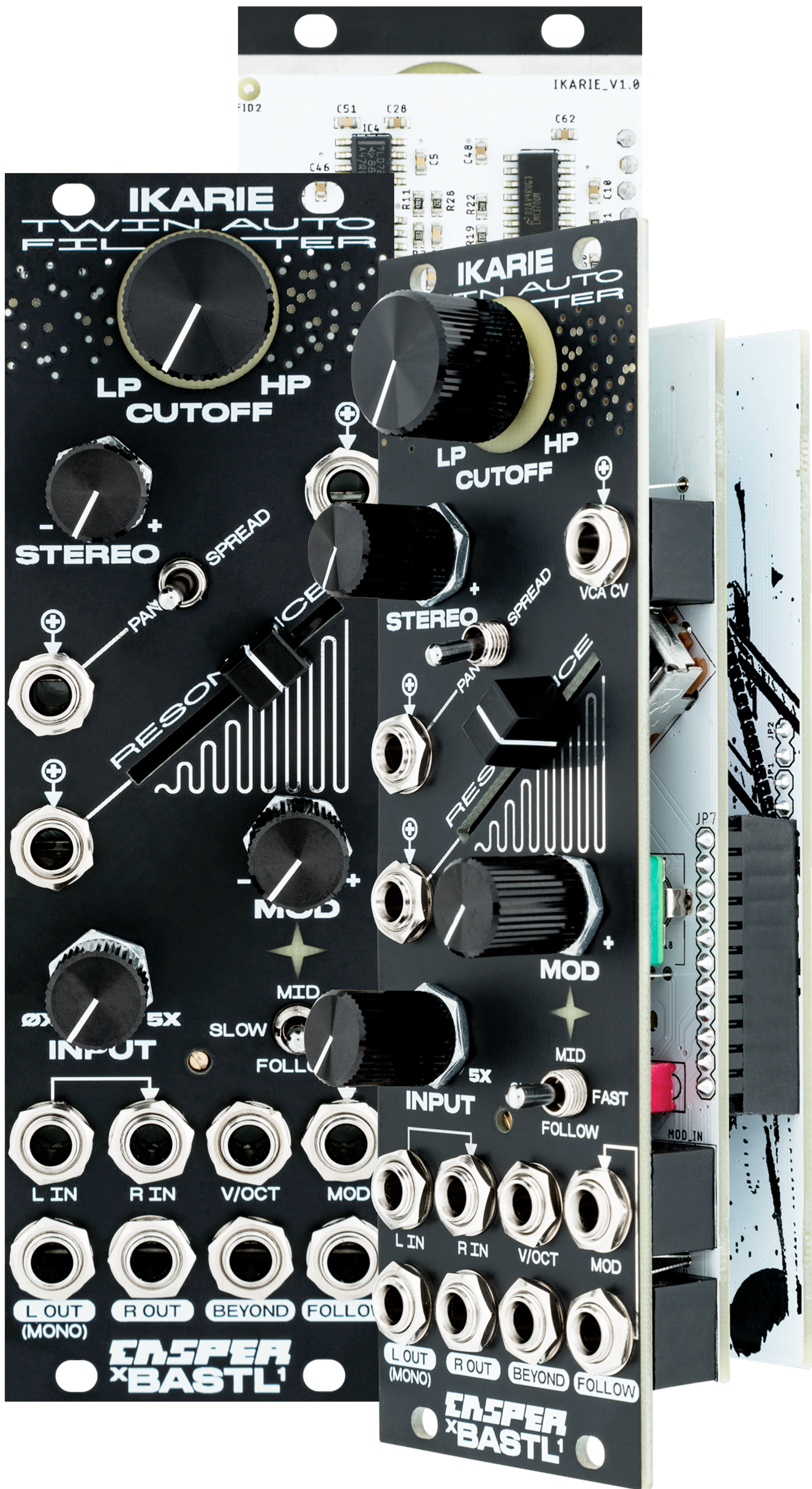

CASPER xBASTL

IKARIE

TWIN AUTO FILTER

Ikarie is a uniquely sculpted, flexible stereo or dual peak filter module. It can continuously transition between lowpass and highpass filtering with a single knob. It also packs in an envelope follower for the incoming audio signal, which comes in handy when you're looking to increase your sound's internal animation.

Two parallel filter cores can be modulated in sync for work in the stereo realm, set apart for unique stereo effects (with either mono or stereo signal at the base), or chained together to make a 24 dB filter.

With only the mono output of the filter used, Ikarie behaves as a dual peak filter, which evokes formant-type sounds and rich, at will piercing, throaty resonance. The Beyond output gives you the spectral difference of the two filters, effectively turning the unit into a so-called twin peak filter.

Add an internal VCA, CV control over panning and resonance, optional overdrive of the input, and you can explore a vast universe of sound design possibilities, from liquidy through pinged percussive to lush and eerie. All in a very compact form factor, with tons of space for precision and creativity.

This module results from a collaboration between Václav Peloušek of Bastl Instruments and Peter Edwards of Casperelectronics. While Edwards' obsessive attention to detail gave this filter a uniquely balanced resonance and envelope response, the expertise of Peloušek delivered a one-hand user experience filter with a distinctive control scheme at a minimal footprint.

The module's name alludes to the 1963 Czech sci-fi movie Ikarie XB-1 (released as *Voyage to the End of the Universe* in the US), and the film served as the module's inspiration in many aspects. Long before *Solaris*, *Space Odyssey 2001*, or *Star Wars*, Ikarie focused on the subject of space exploration, and it paved the way for many to come. With its early electronic sound design and musical experimentation under the lead of Zdeněk Liška, immersive cinematography, and

impressive production level, it remains one of the most original and exciting film titles in the science fiction genre. Bastl & Casper's *Ikarie* proudly carries the flag of this cinematic world.

FEATURES

- two parallel filter cores left and right
- based on 12dB/oct state variable filter topology
- unique lowpass / highpass switching control scheme
- well balanced voltage controlled resonance circuit
- envelope follower with 3 decay settings
- input gain up to 5 times
- stereo modulation - either panning of filter detuning
- flexible patch programmable topology
- Beyond output for difference spectrums (twin peak filter)
- modulation attenuverter
- v/oct input with scaling trimmer accessible from the front panel
- output stereo VCA

TECHNICAL DETAILS

- power consumption: +12V: 100mA, - 12V: 95mA
- 8HP
- 35mm
- PTC and fuse protected 16pin power connector

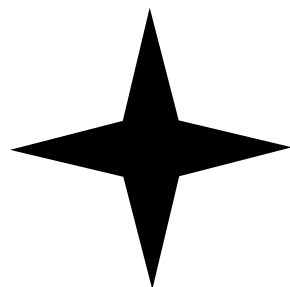

MANUAL

All controls on Ikarie affect each other in a way. It is a very interactive, organic circuit, where all settings matter. The default clean setting to start with would be putting all knobs into center position and resonance fader to minimum.

TWO FILTERS

Ikarie has 2 filters. Called Left and Right, both can be accessed by their respective inputs and outputs. This is useful for filtering stereo signals, or for monophonic multi peak resonance formant filtering.

The two filters are routed in parallel, but can also be routed in series, to increase the steepness of the cutoff. Each filter is 12 dB/oct steep. However, when filtering signal at the L IN, routing L OUT into R IN and listening to R OUT will result in 24 dB/oct steep filtering effect.

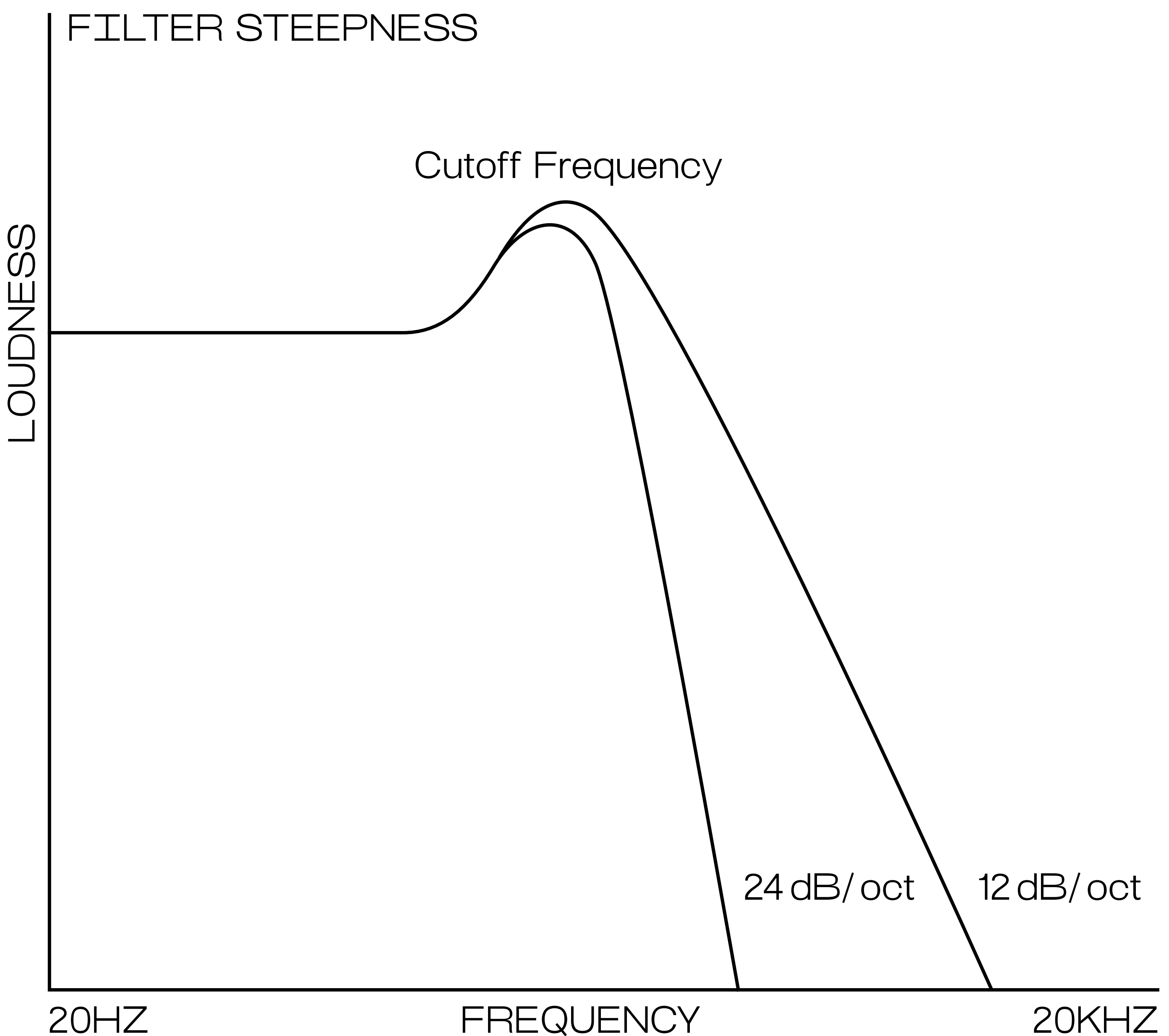

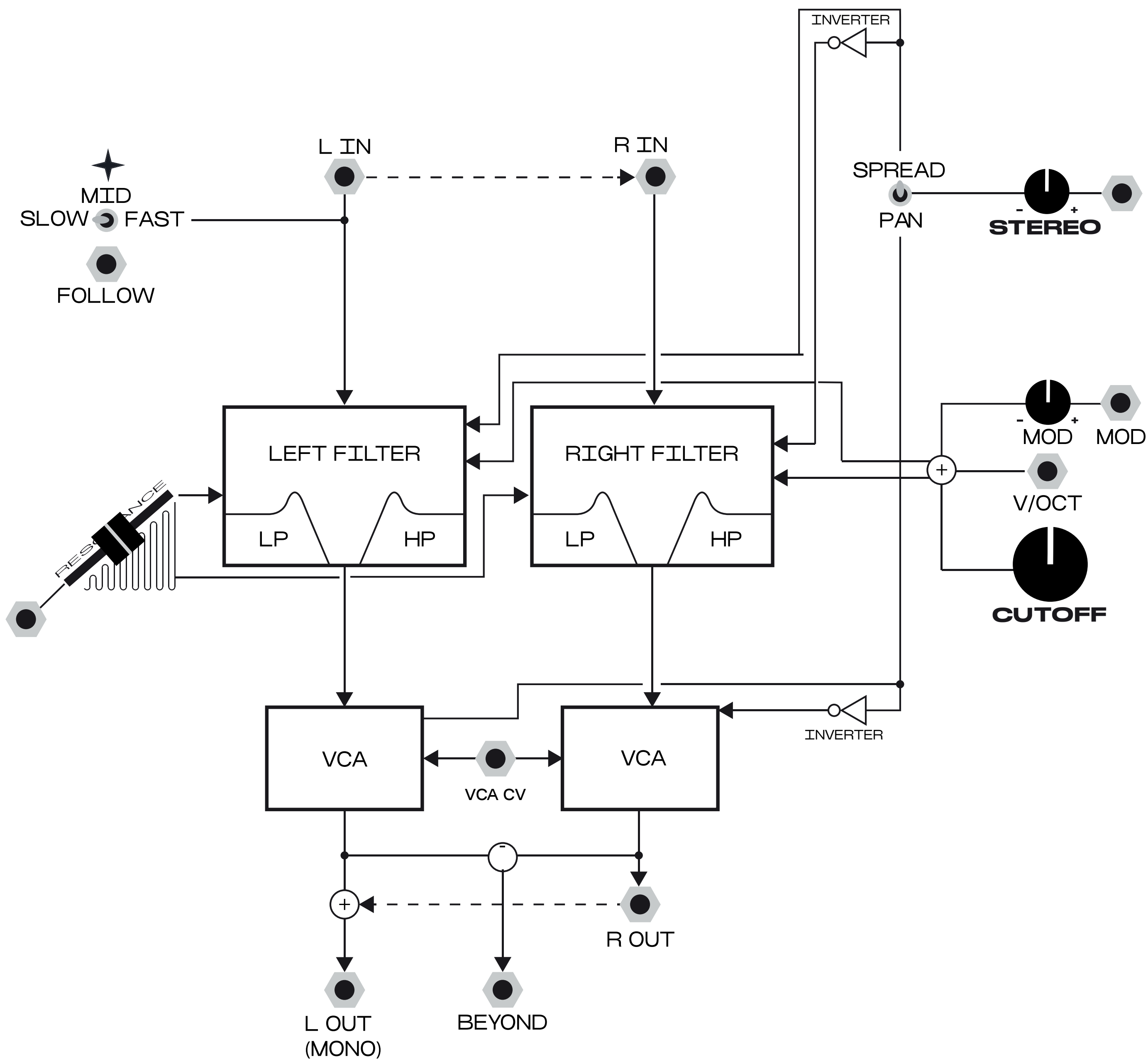

! POWER !

Before connecting the ribbon cable to this module, disconnect your system from power! Double check polarity of the ribbon cable and that it is not shifted in any direction. The red cable should match the -12V rail, both on the module and on the bus board.

! PLEASE MAKE SURE OF THE FOLLOWING

- you have a standard pinout eurorack bus board
- you have +12V and -12V rails on that bus board
- the power rails are not overloaded by current

Although there are protection circuits in this device, we do not take any responsibility for damage caused by the wrong power supply connection. After you connected everything, double-checked it and closed your system, so no power lines can be touched by hand, turn on your system and test the module.

FRONT
BACK

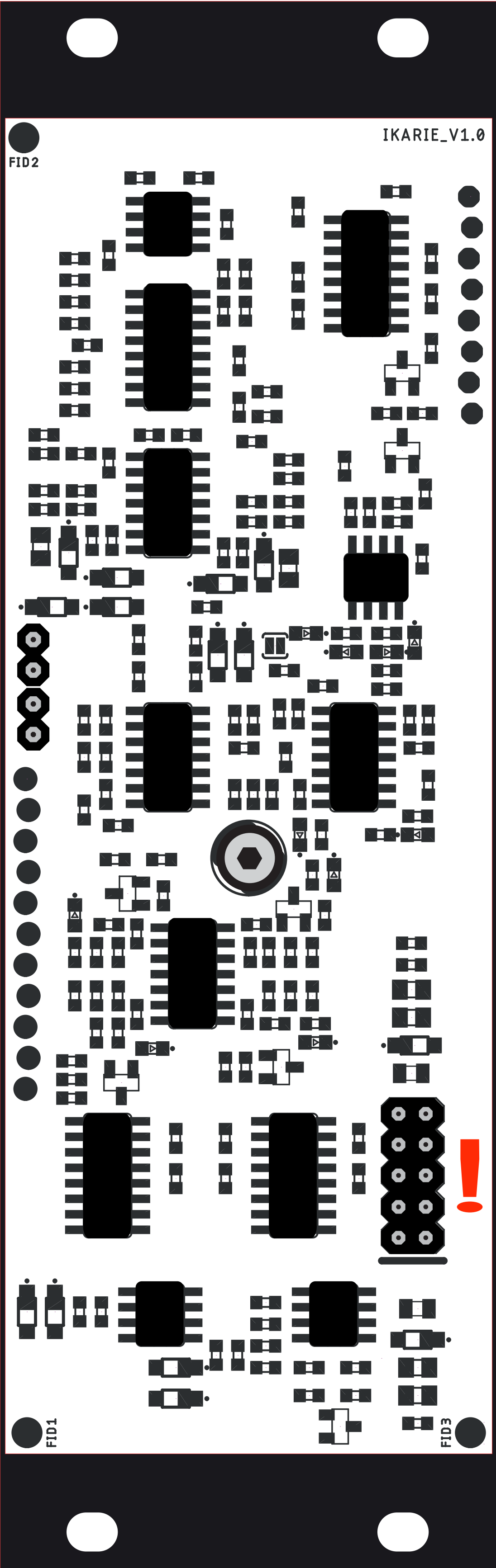

IKARIE
TWIN AUTO
FILTER



LP HP
CUTOFF

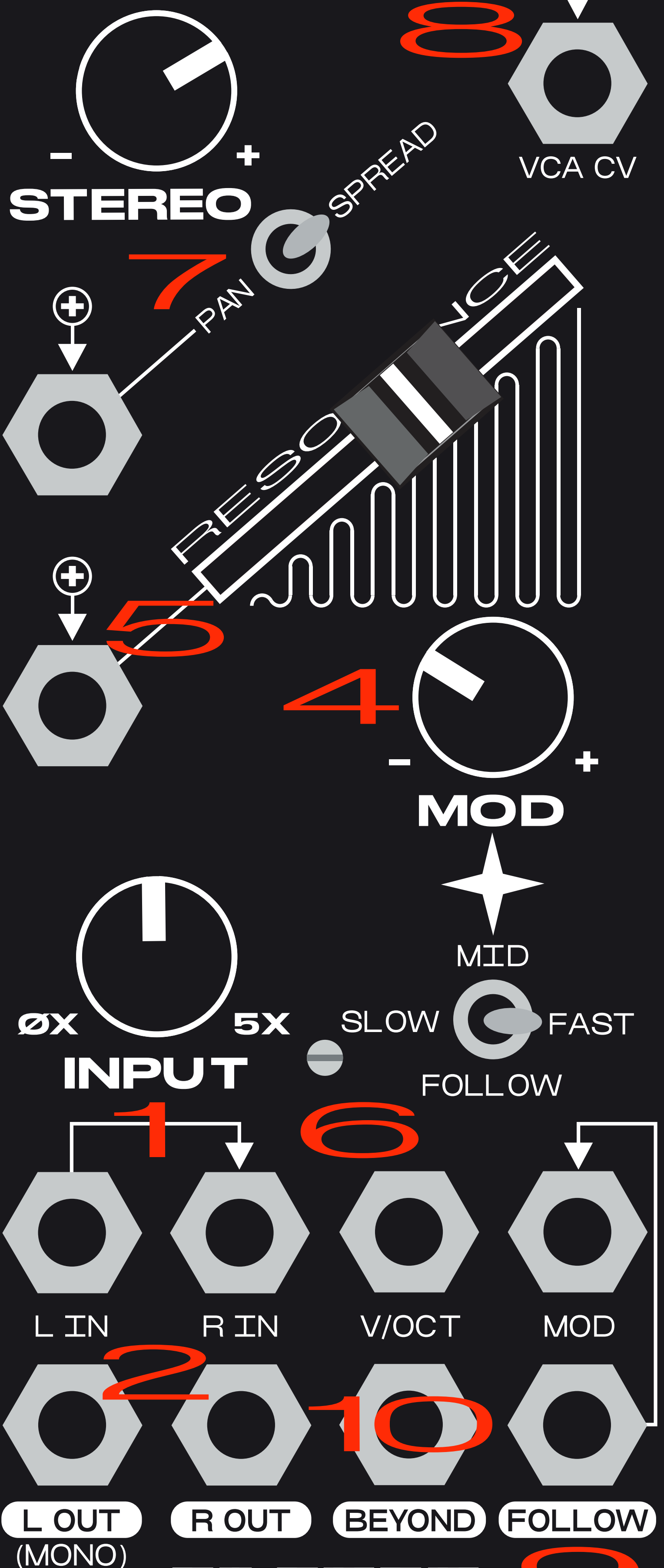

ENSPER
X BASTL



CONTROLS

! POWER

1 INPUTS - L IN, R IN

2 OUTPUTS - L OUT, R OUTV

3 CUTOFF

4 MOD

5 RESONANCE

6 V/OCT

7 STEREO

8 VCA CV

9 FOLLOW

10 BEYOND

PATCH TIPS

FORMANT FILTERING

QUAD ACID

BEYOND STEREO

PINGING & FM PINGING

SELF OSCILLATION

POST FILTER RING MODULATOR

WAVEFORM CROSSFADING

AGGRESSIVE 24DB FILTERING

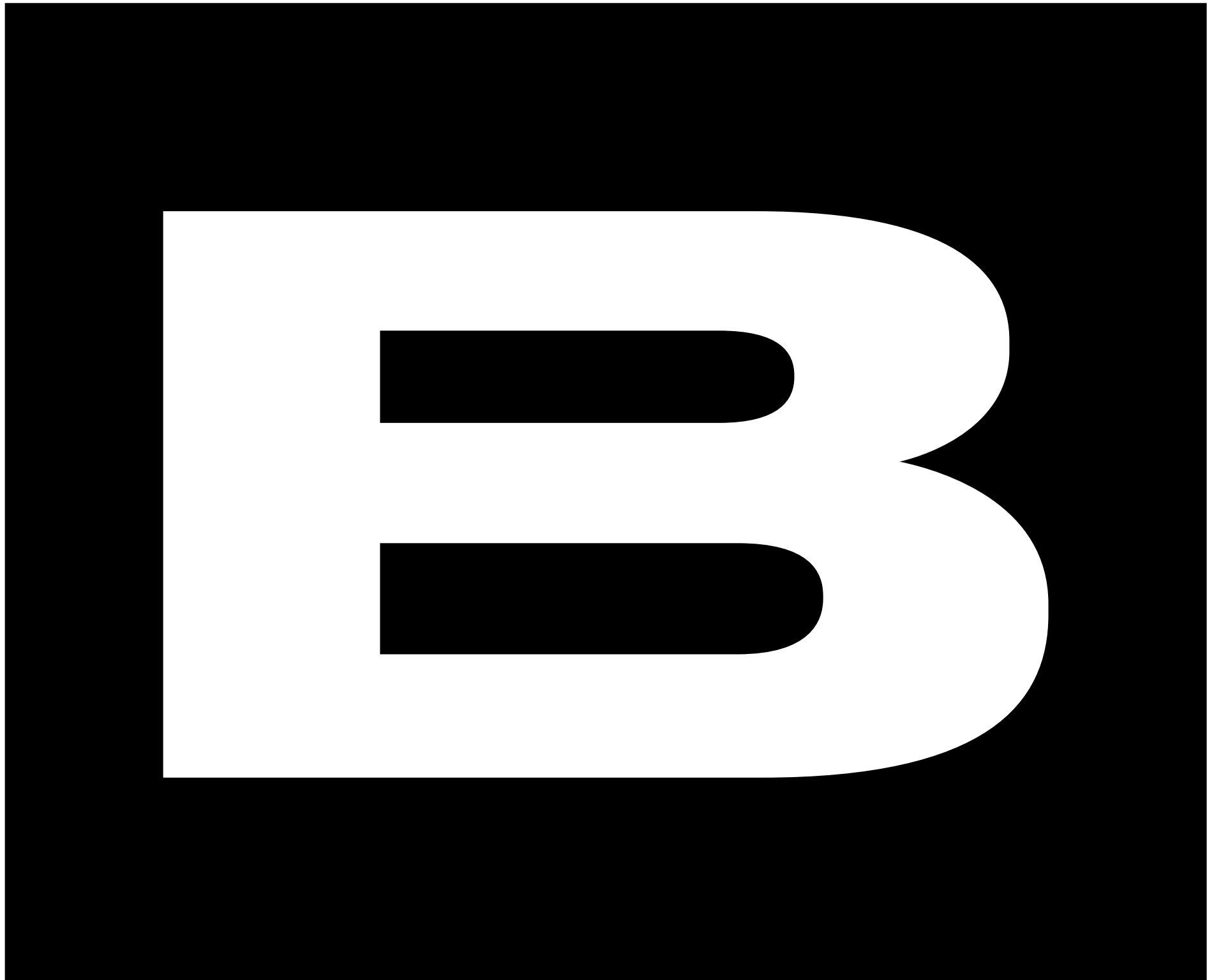

B

1 INPUTS

- L IN, R IN

Connect signal to the L IN and it will be normalised to R IN, unless you connect a different signal to R IN. Turn the INPUT knob to increase input level. Ikarie is super sensitive to the input level and the character of the filter changes a lot under different settings of the INPUT. Going from silent to 5 times gain, Ikarie offers clean and balanced resonances when turned mid way, and overdriven character that does not lose bass, but keeps the resonant sweep in the high pass setting. The input gain can be also used to amplify most line level signals to the optimal operational level for this filter.

2 OUTPUTS

- L OUT, R OUT

Listen thru L OUT only for both left and right channels mixed together. Connect cables to both L OUT and R OUT for stereo output. Going into L IN and only listening to L OUT results in parallel filtering with two resonant peaks.

3 CUTOFF

The CUTOFF knob provides an open filter in the centre position and renders LP (lowpass) filter sweep when turning CCW (counter clockwise) and HP (highpass) filter sweep when turned CW (clockwise). LP mode will cut high frequencies from the frequency spectrum and HP mode will cut low frequencies from the spectrum.

Please note: the filters are voltage controlled with CV - MOD, V/OCT or STEREO - thus centre position of the knob does not always translate into an open filter.

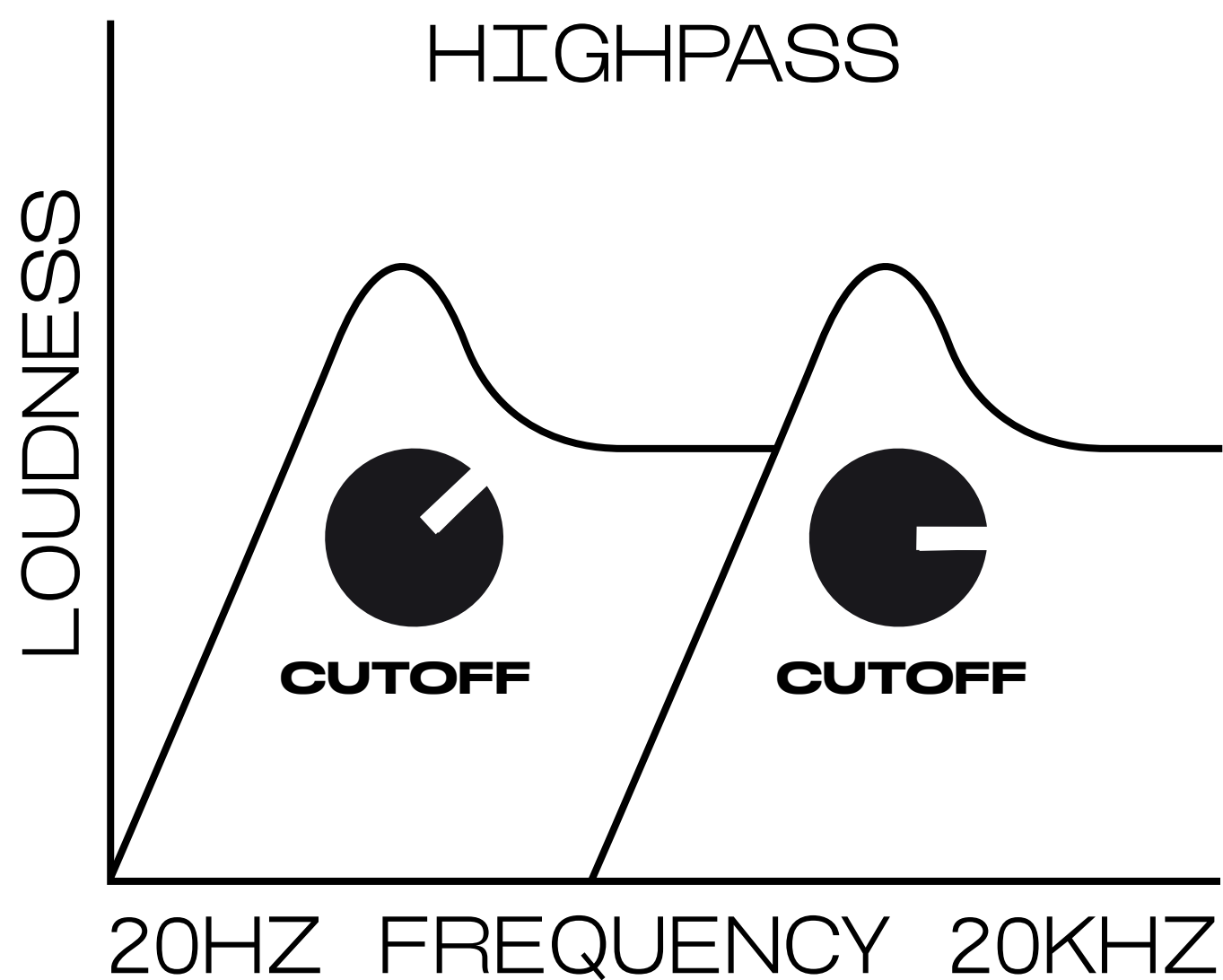
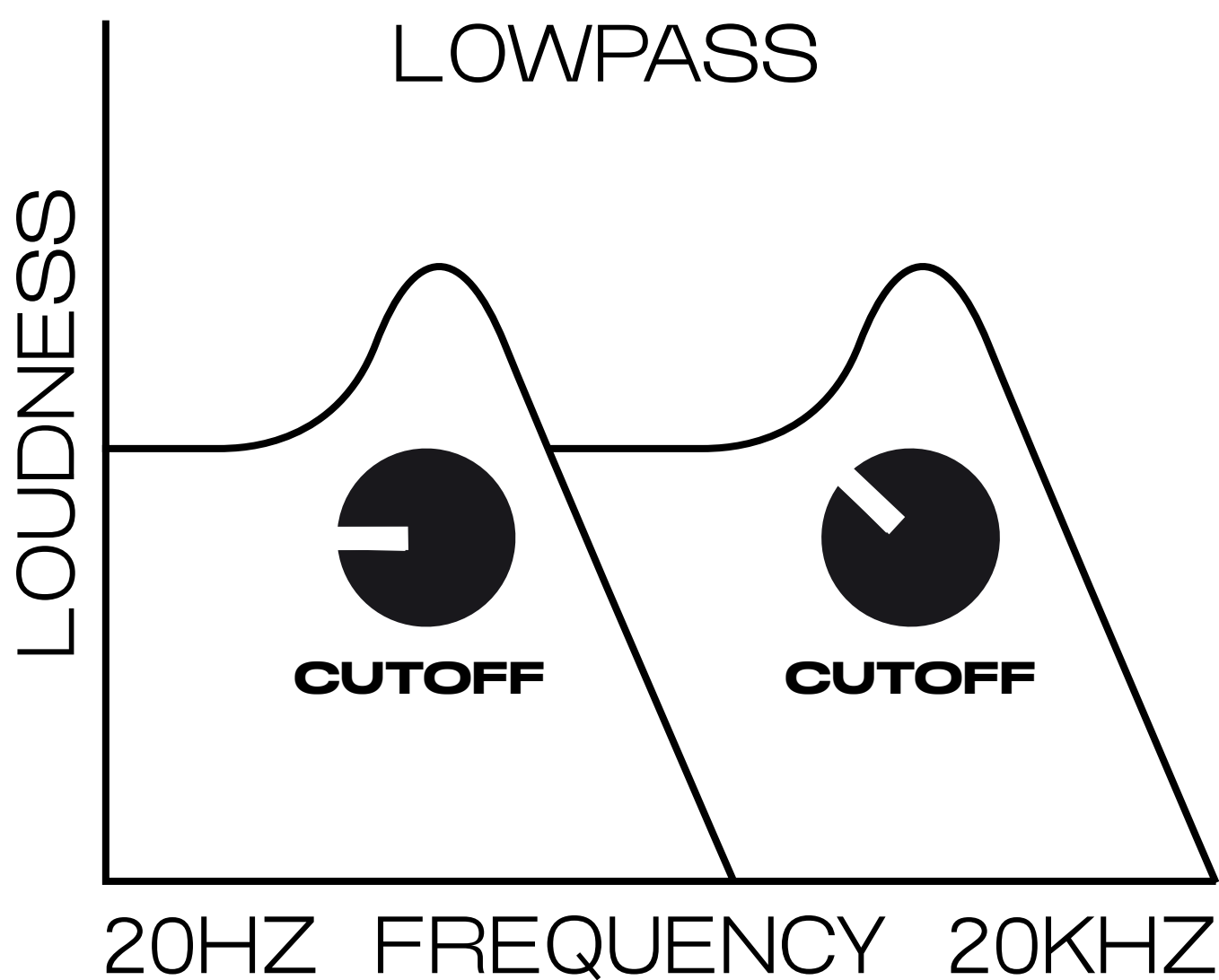

4 MOD

Use the MOD input to control the CUTOFF of both left and right filters in tandem. The MOD attenuverter knob does not let any modulation thru when in the centre position. Turning it CW opens the modulation for the CUTOFF in the positive direction and turning it CCW inverts the signal and modulates the CUTOFF in the opposite direction.

Centre the MOD knob when not using any modulation. Note that the FOLLOW signal (see section 9) is normalised into the MOD input jack. This means the filter is already modulated by the FOLLOW, unless you connect a different signal to the MOD input.

5 RESONANCE

RESONANCE fader can emphasise the CUTOFF frequency by partially or fully selfoscillating on that frequency. The result is a resonant peak in the corresponding frequency spectrum. The more resonance you add, the more profound the impact on the final sound will be, especially when modulating the CUTOFF frequency. With no signal present at the input of the filter, or with the INPUT turned fully CCW, Ikarie will self oscillate. This results in a Sine waveform being generated on the outputs. With higher levels of RESONANCE, the filter becomes an unstable resonator, which is very handy for pinged sounds. Connect rhythmic trigger pulses to the L IN or R IN, bring up the INPUT knob, and listen to what happens.

RESONANCE can also be controlled by CV. Until you plug a cable into the RESONANCE input, the fader acts as the main RESONANCE control. As soon as you start using the CV input, the fader turns into an attenuator for the input voltage. In this case, the fader sets the cap for resonance level the modulation signal can reach.

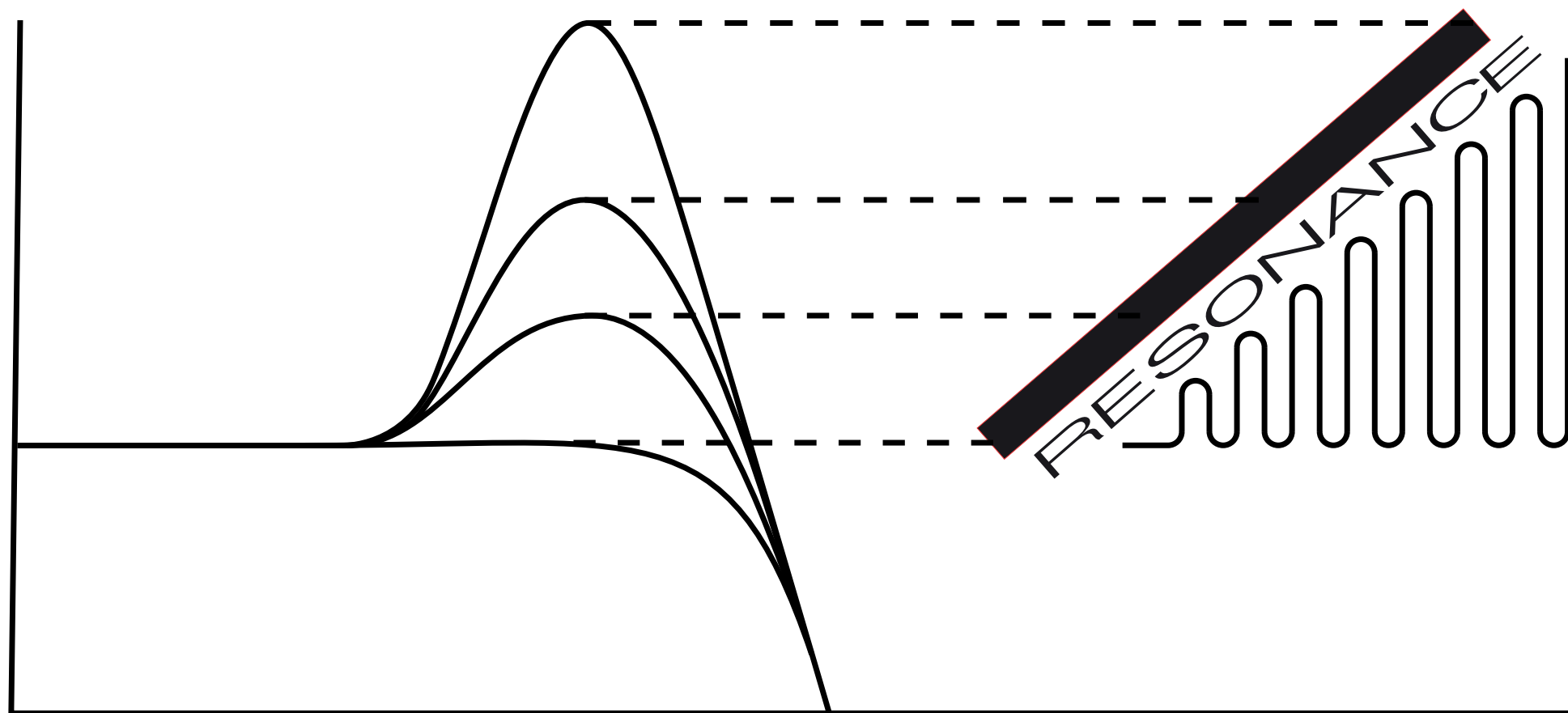

TIP: for achieving extremely exaggerated external resonances (better called feedback in this case), you can plug one of the outputs (R OUT or L OUT) into one of the inputs (L IN or R IN).

6 V/OCT

Use the V/OCT input as a second modulation input that modulates both filters in sync. This input corresponds to the volt per octave standard, which means adding one volt to the modulation signal doubles the CUTOFF frequency (in other words: tunes the filter one octave higher). Since not all V/OCT inputs in modular synths are calibrated the same way, you can use a flat head screw trimmer on the back to adjust the scaling of the V/OCT input. To calibrate for your V/OCT source, put up RESONANCE to maximum, INPUT to minimum, listen to the R OUT and use any chromatic tuner. Applying 1 volt/1 octave from your source to the V/OCT input should result in the self-oscillating tone going 1 octave higher or lower. If the resulting pitch is flat, turn the trimmer CW. If it is sharp, turn it CCW.

7 STEREO

The STEREO section allows to create stereo effects when used in stereo, or detuned formant filtering/ring modulation when using the filter in mono.

The default state (with no effect) is with the STEREO knob centered.

When the STEREO switch is in the SPREAD setting, turning the STEREO knob CW will result in an increase in the cutoff frequency for the left filter, and decrease for the right filter. Turning it CCW has the opposite effect.

In other words, with the STEREO knob centered, the cutoff frequencies are aligned, and the more you turn the knob in either direction, the more detuned these frequencies become.

When the STEREO switch is in the PAN setting, turning the STEREO knob to the right will decrease the output level of the left filter, and turning it the left will decrease the level of the right filter. This is a basic panning procedure, and it virtually moves the sound source from left to right when listening in stereo. However, when used in mono by listening only to the L OUT, the stereo knob crossfades between the L and R inputs.

Connecting a cable to the STEREO jack will change the function of the STEREO knob to an attenuator, which controls the amount of modulation applied. When turning the STEREO knob CW from the

center, the CV at the input will increasingly affect the stereo field in a non-inverted way, and turning it CCW will have an inverted effect.

8 VCA CV

This unique filter topology uses a VCA pair for each filter to switch from between the LP and HP modes. This also provides the possibility to use these VCAs (voltage controlled amplifiers) after the filter to control final loudness.

With no signal routed to the VCA CV input, the filter operates at normal level. Plugging in a cable will make the filter go silent and increase in loudness when a positive CV is applied to the input. This is useful for modulating final loudness with envelopes or with the internal FOLLOW output to achieve exaggerated gated effects. This input is responsive from 0 volts (silence) to 5 volts (unity gain).

9 FOLLOW

The envelope FOLLOWer section listens to the signal at the left input and converts that signal into control voltage representing loudness of the incoming signal. Therefore it can extract envelopes from the signal and surf on top of the waveform.

The FOLLOW switch can be set to one of three responsivity settings: The SLOW setting has natural release, resulting in pumping effects, the MID setting is tighter and works best with mid range signals, and the FAST setting is more like a full-wave rectifier with almost no slew and is especially useful for adding a hard edge to raw waveform filtering.

The FOLLOW output is normalised to the MOD input of the filter that controls the CUTOFF. Such configuration is often called auto-filter or auto-wah when used in the guitar pedal world. Such configuration can produce envelope driven filter sweeps for signals that are not synthesised using traditional envelopes: samples, physical modeling, or live instruments.

Because the FOLLOW section listens only to left filter input, it can be used to side-chain filter the signal on the right input.

The FOLLOW output can be patched to anywhere on Ikarie to obtain dynamic effect on any of the parameters.

FOLLOW listens to the input after the INPUT knob control, so adjusting the INPUT knob will affect the amplitude of the FOLLOW output as well.

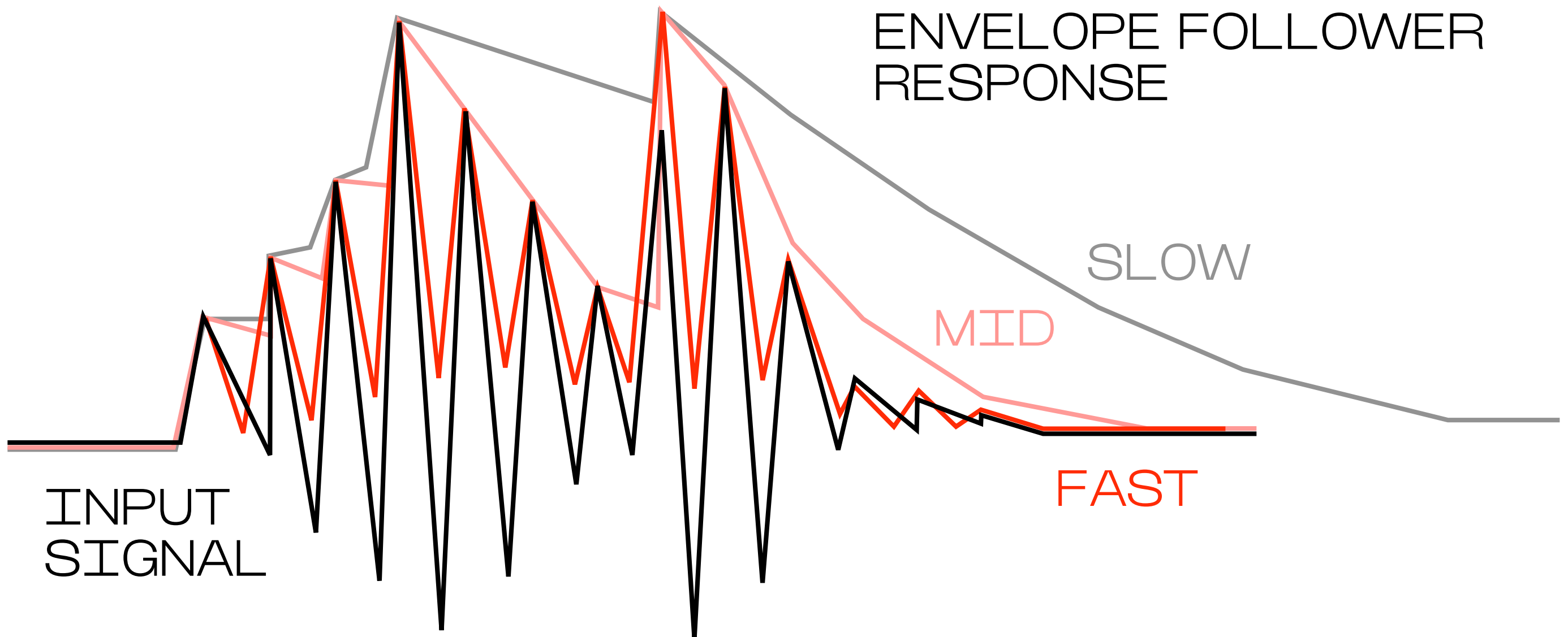

10 BEYOND

Because the two filter signals get subtracted, the resulting spectrum also gets subtracted. Therefore, you can only hear the signal in-between the two cutoff frequencies. That constitutes a flexible band-pass filter, where the STEREO knob in SPREAD mode would define the width of the band-pass filter. Both border cutoff frequencies of such a filter can have resonant peaks when RESONANCE is engaged. This filter topology is often referred to as the twin peak filter.

The BEYOND output can also be used in conjunction with L OUT to create surreal stereo images, or it can be used to modulate any of the filter parameters.

When listening to the BEYOND output and using the STEREO modulation in the PAN mode, you will effectively obtain a ring modulator on the output of the filter. Use a slow CV to achieve tremolo effects, or use audiorate signals to get ring-modulated tones.

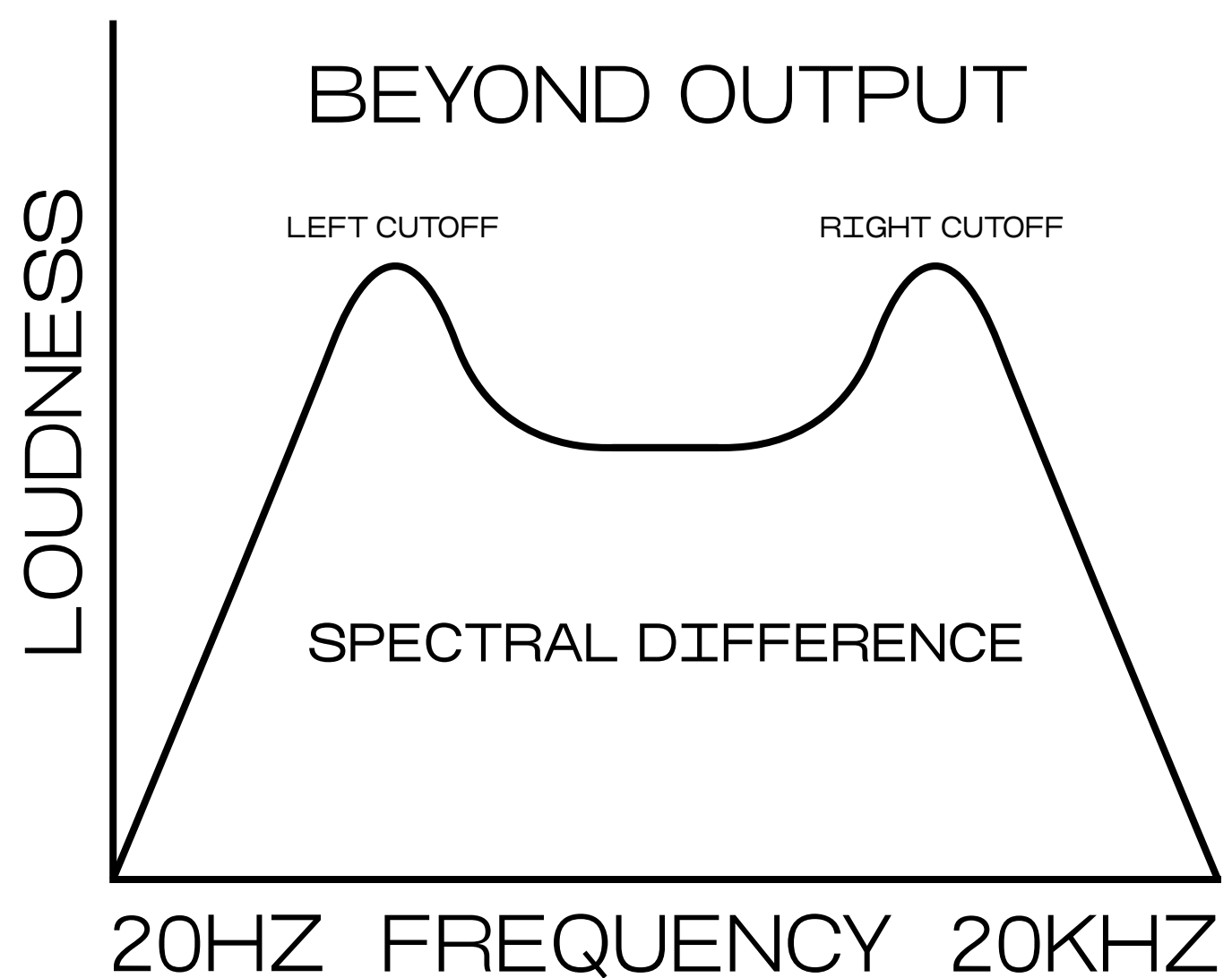
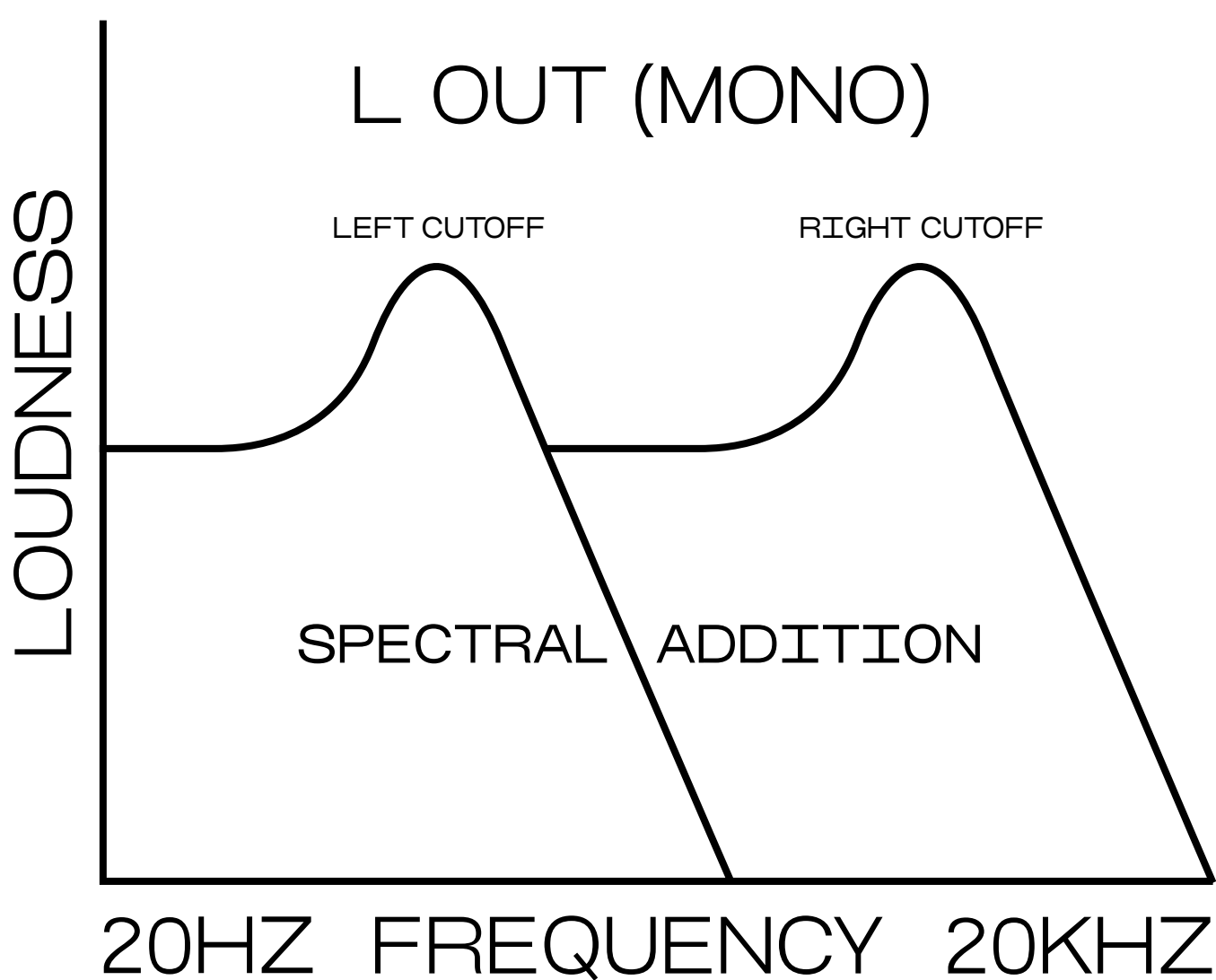

PATCH TIPS

B FORMANT FILTERING

Monophonic filtering technique that emphasises 2 related frequencies as the filter sweeps through the spectrum, evocates vocal/throat like sounds.



B QUAD ACID

4 resonant sweeps in one knob turn

Similar to formant filtering, but the cutoff frequencies are so far apart that they are perceived as independent sweeps



B BEYOND STEREO

Use the L OUT and the BEYOND output as a stereo pair and use some of the techniques mentioned above. The L OUT gives the sum of the frequency spectrum of both filters and BEYOND gives you the difference. When sounds like that collide in a physical acoustic space, they create a strange disorienting feeling. Modulate STEREO at audio rate to get even more experimental stereo depth.

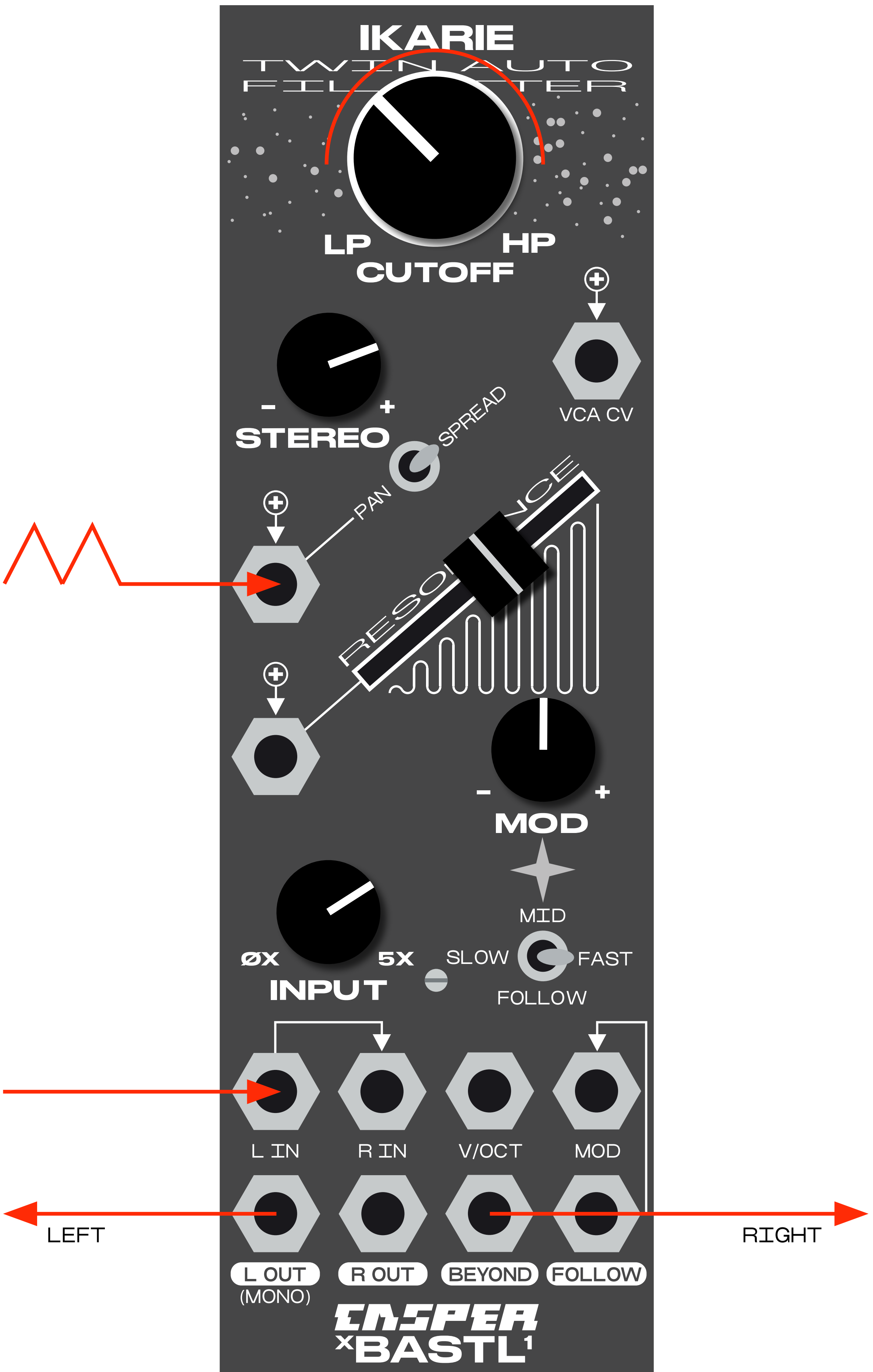

B PINGING & FM PINGING

Use Ikarie as a percussive voice by exciting the resonant circuit with short pulses or noise bursts. INPUT level plays a big part in the sound creation. Take R OUT or BEYOND output, and patch it into the MOD or STEREO input in SPREAD mode to create metallic, alien noises! Use the FOLLOW output to modulate RESONANCE to get even more nuanced control over decay of the sound. You can also have RESONANCE on full and only use the pinged envelope FOLLOWer to control the output VCA CV jack.

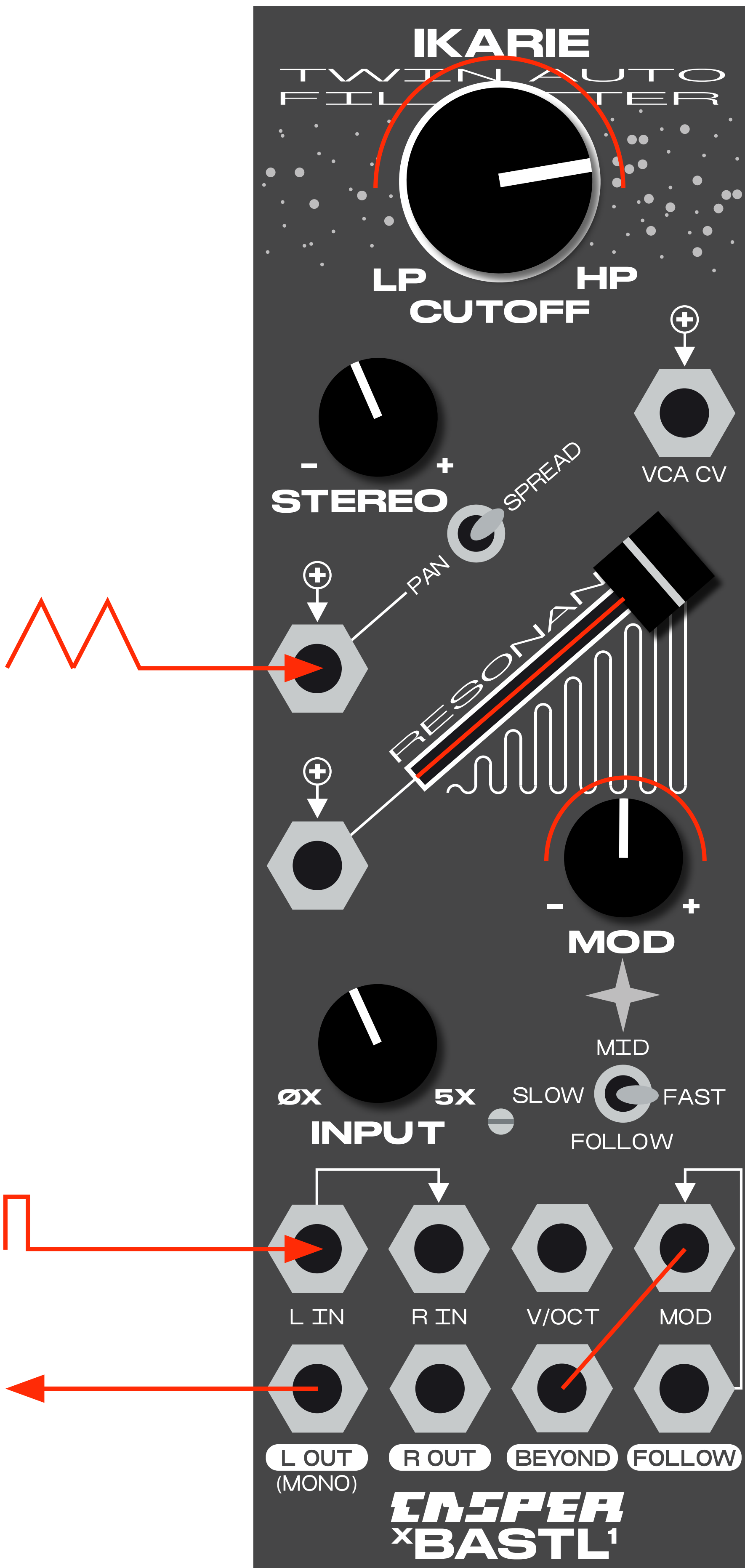



SELF OSCILLATION

Use *Ikarie* as a chaotic, unstable noise/tone generator by creating external feedback. Anything goes - just explore!

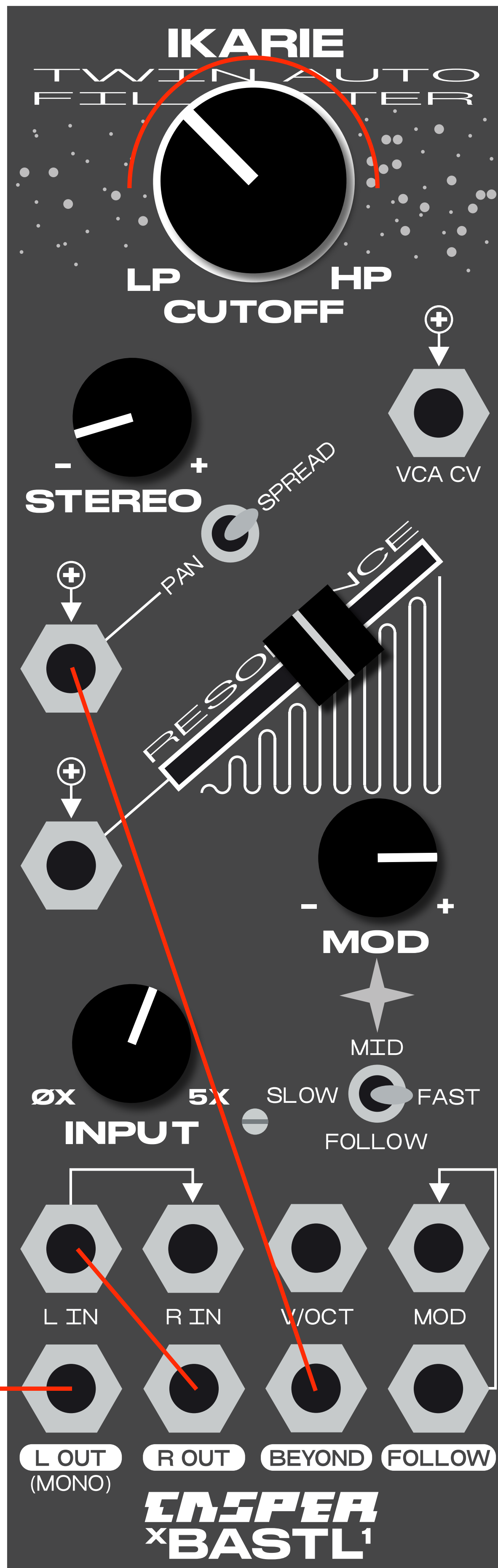



POST FILTER RING MODULATOR

Audiorate modulate STEREO in the PAN setting and listen to the BEYOND output.

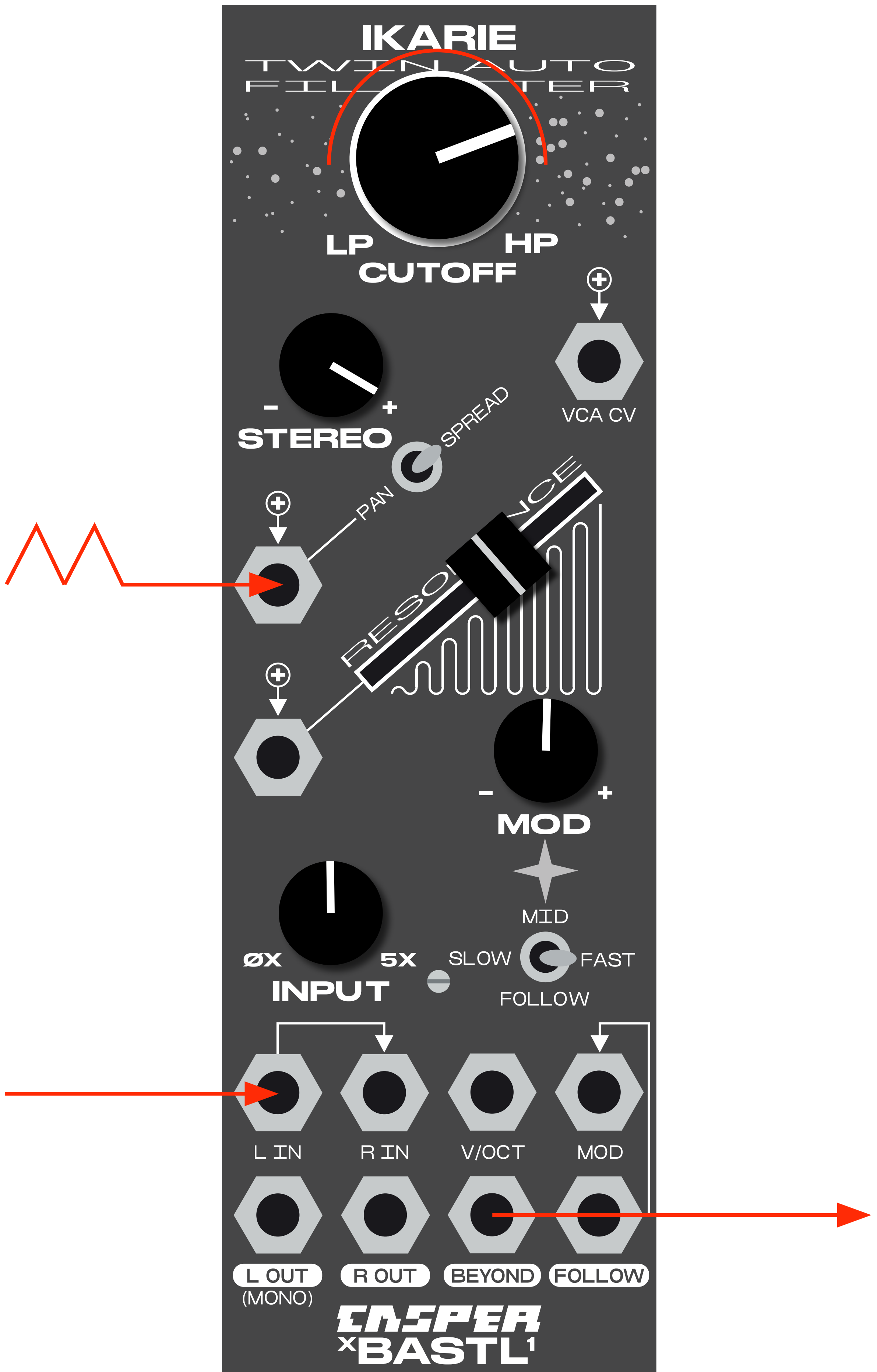



WAVEFORM CROSSFADING

The PAN mode of STEREO balances levels of the left and right filter. By listening only to the L OUT, you can use it to crossfade between differently filtered waveforms. Control it slowly or at audiorate.

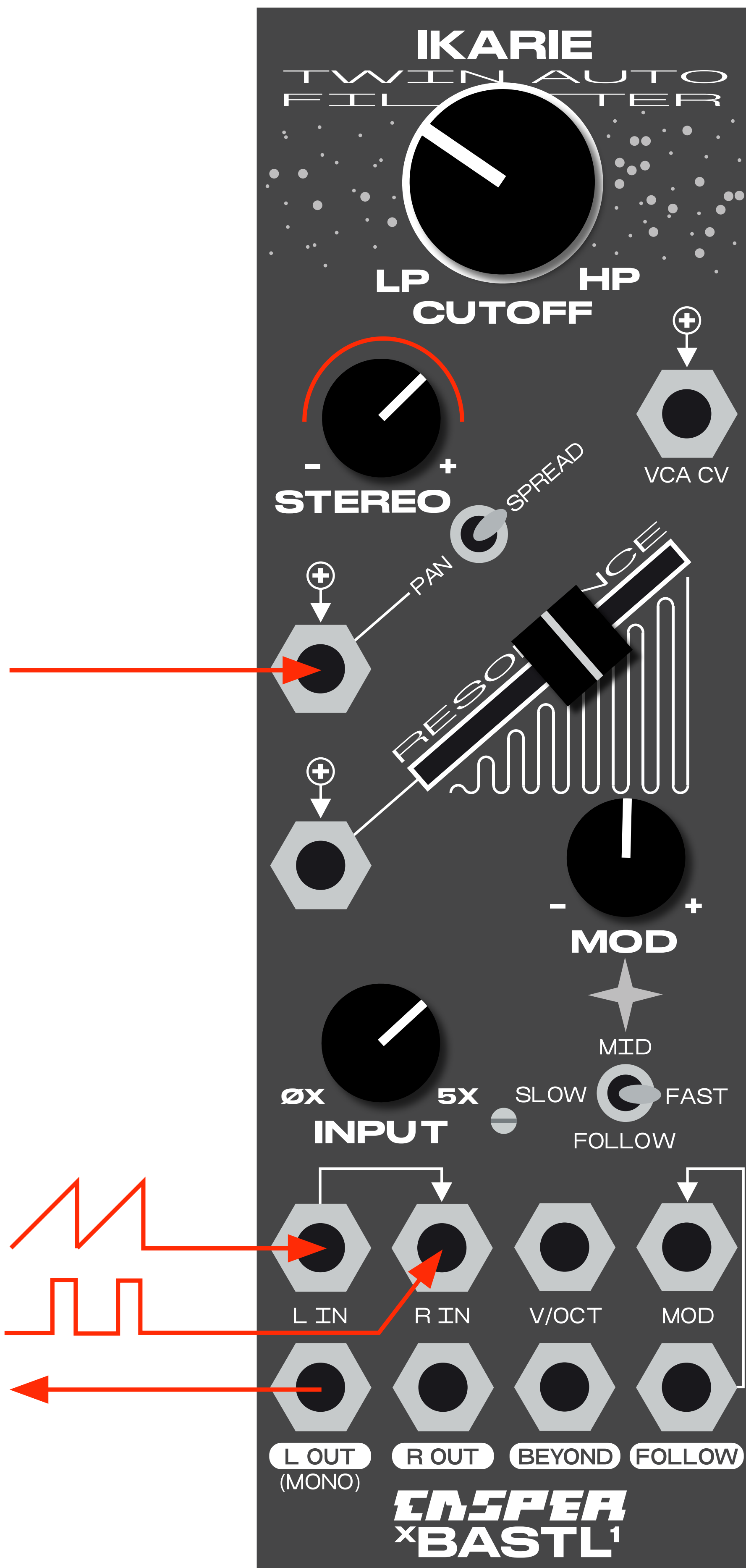



AGGRESSIVE 24DB FILTERING

Feed audio to L IN, patch L OUT to R IN, and listen thru R OUT for serial 24dB filtering. Adding INPUT gain, resonance, STEREO detuning or fast envelope FOLLOWer modulation to the mix will result in brutal sounds.

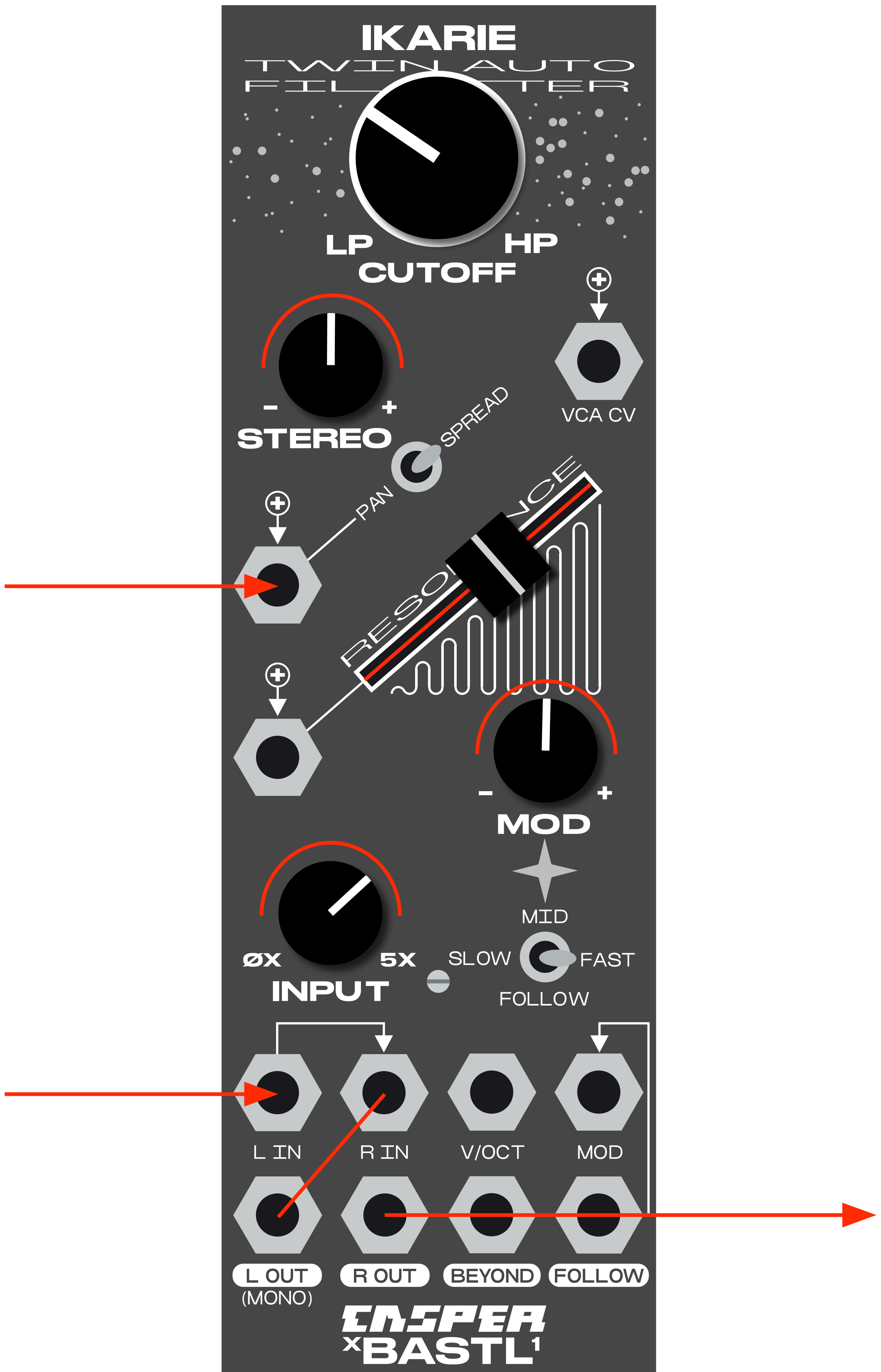

ENSEPERA XBASTL¹

MORE INFO
AND VIDEO TUTORIALS

WWW.BASTL-INSTRUMENTS.COM