

# DARK ENERGY II

Owners Manual



DOEPFER MUSIKELEKTRONIK GMBH

## **Safety Instructions**

*Please follow the instructions for use of the instrument carefully because this will guarantee proper operation of the instrument. Due to the fact that these instructions touch on Product Liability, it is absolutely imperative that they be read carefully. Any claim for defect will be rejected if one or more of the items has not been observed.*

*Disregard of the instructions can void the two years covered by warranty.*

*The instrument may only be operated at the voltage stated on the power input on the rear panel. Before opening the case, disconnect both power plug and power adaptor.*

*All eventual modifications are to be performed by a qualified person only in accordance with valid safety instructions. With the introduction of a third person, the warranty will be void. In case of a destroyed warranty seal, any warranty claim will be rejected.*

*The instrument must never be operated outdoors but solely in dry rooms. Never use the instrument in a humid or wet environment, nor near flammable goods.*

*No liquids or conducting substances must get into the instrument. Should this be the case, the instrument is to be disconnected from mains power immediately and examined, cleaned and possibly repaired by a qualified technician.*

*Never expose the instrument to temperatures above +50° C or below -10° C. Before operation, the instrument should have a temperature of at least 10°C. Do not expose the instrument to direct sunlight. Do not install the instrument near heat sources like heaters, open fire places, central heating etc. Keep the top of the instrument clear in order to allow proper ventilation, otherwise the instrument could eventually overheat.*

*Never place heavy objects on the instrument.*

*Transport the instrument carefully, never let it drop or fall over. Make sure that during transport and in use the instrument is supported properly and cannot drop, slip or fall over because people might get injured.*

*Never use the instrument in the immediate proximity of electronic devices (e.g. monitors, power supplies, computers) as these interferences could cause malfunctions within Dark Energy II and corrupt memory data.*

*The instrument is to be shipped in the original packaging only. Any instrument shipped to us for return, exchange, warranty repair, update or examination has to be in its original packaging! All other deliveries will be rejected. Therefore, make sure you keep the original packaging and technical documentation.*

*The instrument may only be used for the purpose described in this operating manual. Due to safety reasons, the instrument must never be used for other purposes.*

*When using the instrument in Germany, the appropriate VDE standards are to be followed. The following standards are of special importance: DIN VDE 0100 (Teil 300/11.85, Teil 410/11.83, Teil 481/10.87), DIN VDE 0532 (Teil 1/03.82), DIN VDE 0550 (Teil 1/12.69), DIN VDE 0551 (05.72), DIN VDE 0551e (06.75), DIN VDE 0700 (Teil 1/02.81, Teil 207/10.82), DIN VDE 0711 (Teil 500/10.89), DIN VDE 0860 (05.89), DIN VDE 0869 (01.85). VDE papers can be obtained from the VDE-Verlag GmbH, Berlin.*

DOEPFER

# DARK ENERGY II

## Owners Manual



---

### Content:

#### 1. Introduction

1.1. Preface.....	4
1.2. Preparations.....	5
1.3. Check it out.....	6

#### 2. Overview..... 8

#### 3. Functions

3.1. Signal path.....	10
3.2. The Modules	
3.2.1. VCO.....	12
3.2.2. VCF.....	14
3.2.3. VCA.....	16
3.2.4. ADSR.....	17
3.2.5. LFO1 and LFO2.....	18

#### 3.3. USB/MIDI Interface

3.3.1. Connection / MIDI Channel.....	19
3.3.2. MIDI to CV Interface.....	20
3.3.3. Learn-Mode / MIDI-Functions.....	21
3.3.4. Reset.....	24

3.4. Linking / Stacking of several Dark Energy II.....	25
3.5. Modifications.....	25
3.6. Firmware Update .....	25

#### 4. Nuts and Bolts of Soundgeneration..... 26

#### 5. Addendum

Service and Terms of Warranty.....	43
Imprint.....	43

## 1. Introduction

### 1.1. Preface

Welcome to Dark Energy II. As you might have guessed already, your newly purchased Dark Energy II is not a tool for space research, neither is it suitable for studies in astrophysics. Yet, we find these topics as fascinating as music technology - reason enough to celebrate Hubble & Co's amazing discoveries a bit and call our brand-new synthesizer Dark Energy II.

*Doepfer says „thank you!“*

First of all we would like to thank you for purchasing Dark Energy II! We really appreciate your choice and promise you an extraordinary support throughout, including useful information, easy service, and innovative product development.

May your Dark Energy II be an important source of creative power for ages to come.

*What's this?*

Dark Energy II is a monophonic, analog synthesizer with USB and MIDI interface. Its entire sound generation as well as all its modulation sources is 100% analog. Only the USB/MIDI interface uses, of course, digital component parts.

Dark Energy II is housed in a rugged black sheet metal case with wooden side panels. Only high-quality potentiometers (referred to as „pot“, in case you should be wondering where the „weed“ is...) with metal shafts have been used. Each pot has been mounted firmly to the chassis. The space between the knobs is wider than e. g. on the A-100 modular system, and we made use of knobs which have a classy vintage look to them. Dark Energy II looks as beautiful as it sounds and is made for extensive live tweaking sessions. You will get all the advantages of analog sound generation as well as direct access to all crucial parameters - forget about confusing menus and tiny displays. Yet, Dark Energy II is a modern tool for sound creation and, thanks to its built-in MIDI/USB interface, can easily be linked with every modern computer-based studio or live-setup. Hooking Dark Energy II up to classic vintage analog equipment or to a Doepfer A-100 modular system is also easy.

*R.t.f.m.!*

We knew it: User manuals are your first choice in literature. Hey, that's great – we're talking the same language here! If you are in doubt about the entertaining qualities of this manual – how dare you! –, please bear in mind that its thorough study will eventually turn out to be quite useful, as it will highly increase the entertaining qualities of your new synthesizer as well. So please do yourself – and us – a big favor: Read (and possibly understand) this friggin' manual! Bless you for your efforts!

In the first section you will find all information needed to hook up Dark Energy II to your setup. After that, you will find a brief overview of its functions. Synthesizer experts may use this as a quickstart guide. You should not skip the complete description of the entire „functions“ section in the next chapter, though - Dark Energy II hides some interesting features. If synthesizer technology and the secrets of subtractive synthesis are totally new to you, please refer to „Nuts and bolts of sound generation“ later on in this manual.

Enough talk - here we go...

## 1.2. Getting started

When you lift Dark Energy II out of its box for the first time, please make sure that everything is in its right place. You will find the following component parts in the *box*:

- Dark Energy II Synthesizer
- wall-wart (12VAC/800mA)
- instrument cable with 1/8" and 1/4" plugs
- USB cable (A-B type)
- two A-100 patch cables
- this owners' manual

*You will also need:*

- A suitable audio system (mixer, amplifier, speaker, or keyboard amp)

To run Dark Energy II via its MIDI-DIN socket, you will also need:

- A MIDI cable to connect a suitable MIDI controlling device / keyboard / computer to Dark Energy II.
- A MIDI-keyboard and / or computer with suitable MIDI sequencer application

To run Dark Energy II via its CV/Gate inputs, you will also need:

- At least two 1/8" plug patch cables – the more, the better – and a suitable sequencer (e.g. the Doepfer sequencer module A-155) or a CV/Gate keyboard (e.g. the Doepfer model A-100).

*Setup:*

Use Dark Energy II in a flat or upright position. Please use a suitable support. The wooden sidepanels can be removed in order to link up two or more units mechanically to make one big device. More information on this topic can be found later on in this manual.

*Connections:*

To run Dark Energy II, you do not necessarily need all its built-in sockets. For a basic setup, you will need just the ones pictured below. Make use of the additional connection terminals and you will expand Dark Energy II's sonic potential a great deal. These connectors will be described along with the corresponding modules later on in this manual.

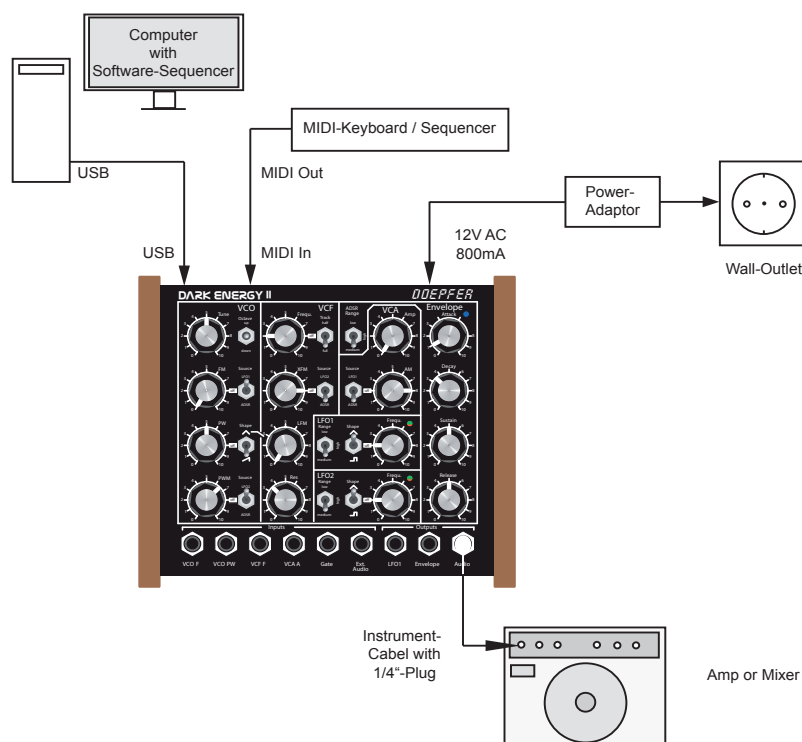

- Power supply:

Connect the included power adaptor („wall wart“) with the 12-15V AC socket on the rear panel of Dark Energy II. **Important: Use this power adaptor only or an equivalent one with exactly the same specs!** A power supply via USB is not possible since the internal analog circuits of Dark Energy II run at +/-12V. If two or more units are running in parallel, each unit needs its own power supply with wall wart. Should need and demand be, we might take offering a bigger wall wart with several power outlets into consideration.

- USB:

Connect Dark Energy II's USB socket with your computer. Any configuration work or driver installation is not required.

- MIDI:

To run Dark Energy II in a conventional MIDI setup without USB, please connect Dark Energy II's MIDI-in socket with the MIDI-out socket of your MIDI controller device (e.g. master keyboard, synthesizer, sequencer).

The default setting of Dark Energy II's MIDI channel is Channel 1. How to change this setting is described on page 19 in the chapter „USB/MIDI interface“.

- Audio:

Connect the „Audio“ output on Dark Energy II's front panel with the audio input of your mixer, amp, etc. Please use the connection cable included.

- CV/Gate:

When controlling Dark Energy II from a CV/Gate sequencer / keyboard, you have to connect at least Gate- and VCO F jacks. Gate triggers the notes, VCO F determines the pitch of the notes. Using additional VCO PW, VCF F and VCA A connections, Dark Energy II's corresponding sound parameters can be controlled dynamically via control voltages. More on this topic later on in this manual.

### 1.3. Check it out

Please set all frontpanel controls to their initial settings as pictured below. The default MIDI channel setting is # 1 and should not be touched at this point.

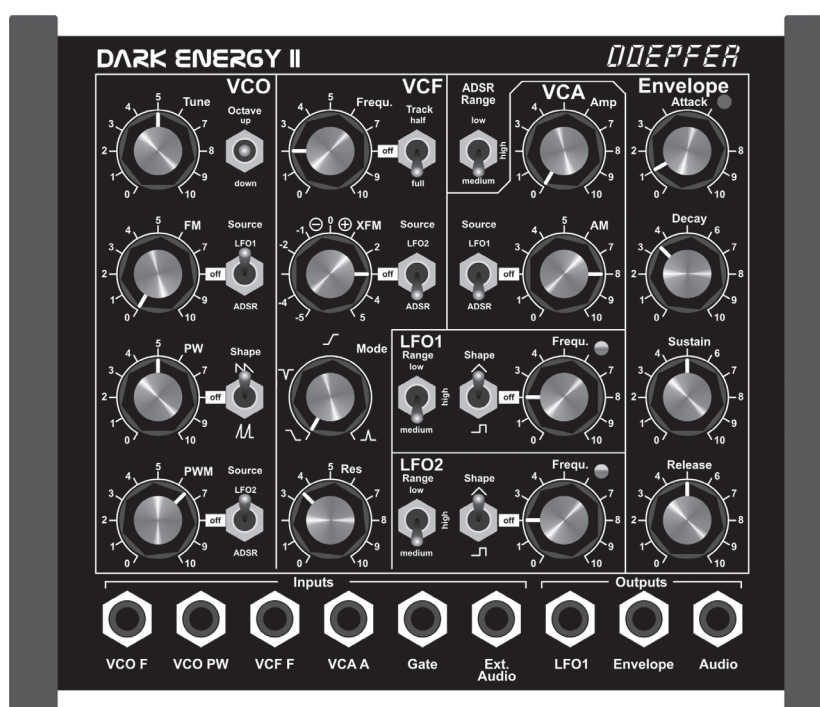

As soon as the power adaptor has been plugged in, Dark Energy II will power up. The LEDs in both LFO sections will now light up and alternate between red and green. The LED on the back panel will flash intermittently for about two seconds and then stay lit permanently.

*First contact:*

Turn the volume control of your amp / mixer fully off BEFORE powering Dark Energy II up. Turn up the volume control of your mixer / amp slowly and play a key on your keyboard. You ought to hear a steady tone now. Choose a comfortable volume. And now - Ladies and Gentlemen, we're floating in space: Welcome to Dark Energy II !

The sound currently generated depends on the setting of all knobs and switches. It will be the easiest to create musically useful patches if you start with this basic setting and „compose“ your sounds step by step from that point onwards.

We will now have a brief look at Dark Energy II's sound generation and sound-modelling modules. A detailed description of all functions will follow later on.

Now that you have tweaked all knobs and switches to their initial settings, you will hear a simple and steady tone.

The oscillator generates a simple square wave that is audible at the audio output, yet without being modified in any way. Now turn the VCO tune control and move the octave switch: You can control the tuning and the pitch range of the tone.

As soon as you crank up the FM control, you will notice an „automatic“ change in tuning: LFO1 is selected as a modulation source and its control voltage generates a periodic change in tuning or VCO frequency respectively.

Now turn the „LFO1 Freq.“ control. You will hear a change in the modulation speed or LFO1 frequency respectively.

Now let's have a brief look at the filter section (VCF): Turn its „Freq.“ pot slowly counter-clockwise. You will hear the sound becoming gradually „duller“ until it becomes inaudible. Now turn the „Freq.“ pot to 12 o'clock position and crank up the XFM control slowly. You will hear a periodic modulation of the timbre by LFO2. Again, you can alter the modulation speed using the LFO2 Freq. pot. Play a couple of keys and change the settings of the envelope section. You will notice a change in the loudness contour of the notes. When you turn the „Source“ switches in the VCO and VCF section to the „ADSR“ position (the knobs FM and XFM have to be cranked up to at least 10 o'clock position), the envelope will control not only loudness but also pitch and timbre.

*Please note:*

Dark Energy II's parameters mostly interact with each other in some way or other. That means, there is often more than just one way to achieve a specific result. In other words: If you want a certain parameter to generate a desired result, it might be necessary to set other parameters to another specific value. This might be a bit confusing from time to time. An example:

If the ADSR's sustain knob is at its maximum, turning the decay knob will not have any effect on the sound. All ADSR controls will not have any effect on the timbre of a patch as long as the „Source“ switch of the VCF section is set to LFO2. The same goes for the „Source“ switch in the VCA section.

If you really want to make use of Dark Energy II's full sonic potential, it is important to understand the way the parameters interact with each other. Please do not panic - explore systematically each parameter and its interaction with others. There's nothing you could blow up, and normality will be restored soon if something seems weird to you.

Please also note that the VCO needs at least 20 - 30 minutes warm up until it's tuning remains stable.

If analog subtractive sound synthesis is totally new to you, please refer to the section „Nuts and bolts of sound generation“ on page 26 in this manual.

## 2. Overview

The layout of Dark Energy II is that of a classic monophonic modular synthesizer. Its signal path is hard-wired internally, thus Dark Energy II is very compact and easy to use. The most important modulation routings can be set via toggle switches, additional sockets take or deliver control voltages and allow the connection with external modulation sources. The internal MIDI/USB interface makes easy use within a MIDI setup possible. Dark Energy II can also be used as a MIDI-to-CV/Gate interface. Wow!

**saw waveform based VCO**

- tuning knob
- range switch -1 / 0 / +1 octave
- FM (frequency modulation) knob with selectable modulation source (LFO1 / off / ADSR)
- pulswidth knob for squarewave
- PWM (pulswidth modulation) knob with selectable modulation source (LFO1 / off / ADSR)
- waveform switch (saw / off / triangle)

The sum of the squarewave signal and the waveform selected with the waveform switch is fed into the audio in of the filter module (to disable the squarewave both PW- and PWM-knobs have to be turned fully counter-clockwise).

**12 dB multimode VCF**

- cutoff knob (freq.)
- tracking switch half / off / full (internally connected to the VCO control voltage)
- XFM: exponential frequency modulation knob with positive and negative modulation depth
- source switch selects modulation source LFO2 / off / ADSR
- mode knob continuously crossfades between filter modes lowpass / notch / highpass / bandpass
- resonance knob (up to selfoscillation, depending on mode setting)

**VCA**

- amplitude knob
- AM (amplitude modulation) knob with selectable modulation source (LFO1 / off / ADSR)

**ADSR**

- knobs for Attack, Decay, Sustain and Release
- range switch long / short / medium
- blue LED for envelope activity

**LFO1 and LFO2**

- frequency knobs
- waveform switches (triangle / off / square)
- range switches: low (up to several minutes per cycle) / audio (up to 5 kHz) / medium (normal LFO range from some seconds up to several 10th hertz)
- dual LEDs yellow/red show positive and negative halves of the LFO waves

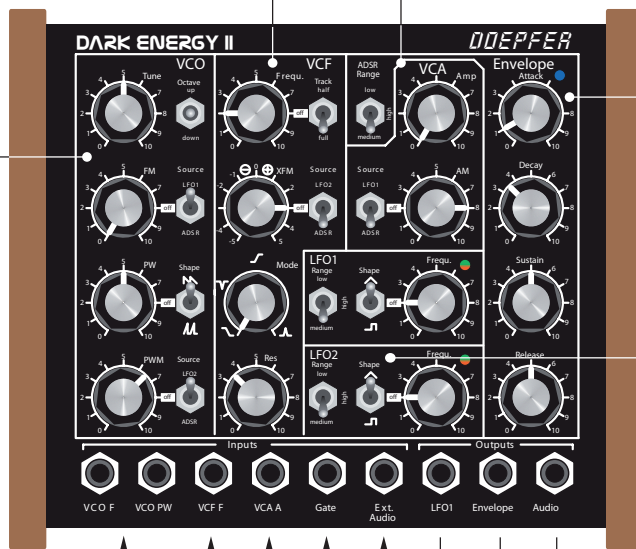

**VCO CV inputs**

- VCO frequency (1V/octave)
- pulswidth of squarewave

**VCF CV input**

- VCF frequency (1V/octave)

**VCA CV input**

- VCA amplitude

**gate input**

**audio input**  
(the connected signal is mixed into the VCF input)

**audio output**

**ADSR CV output**

**LFO1 CV output (inverted)**



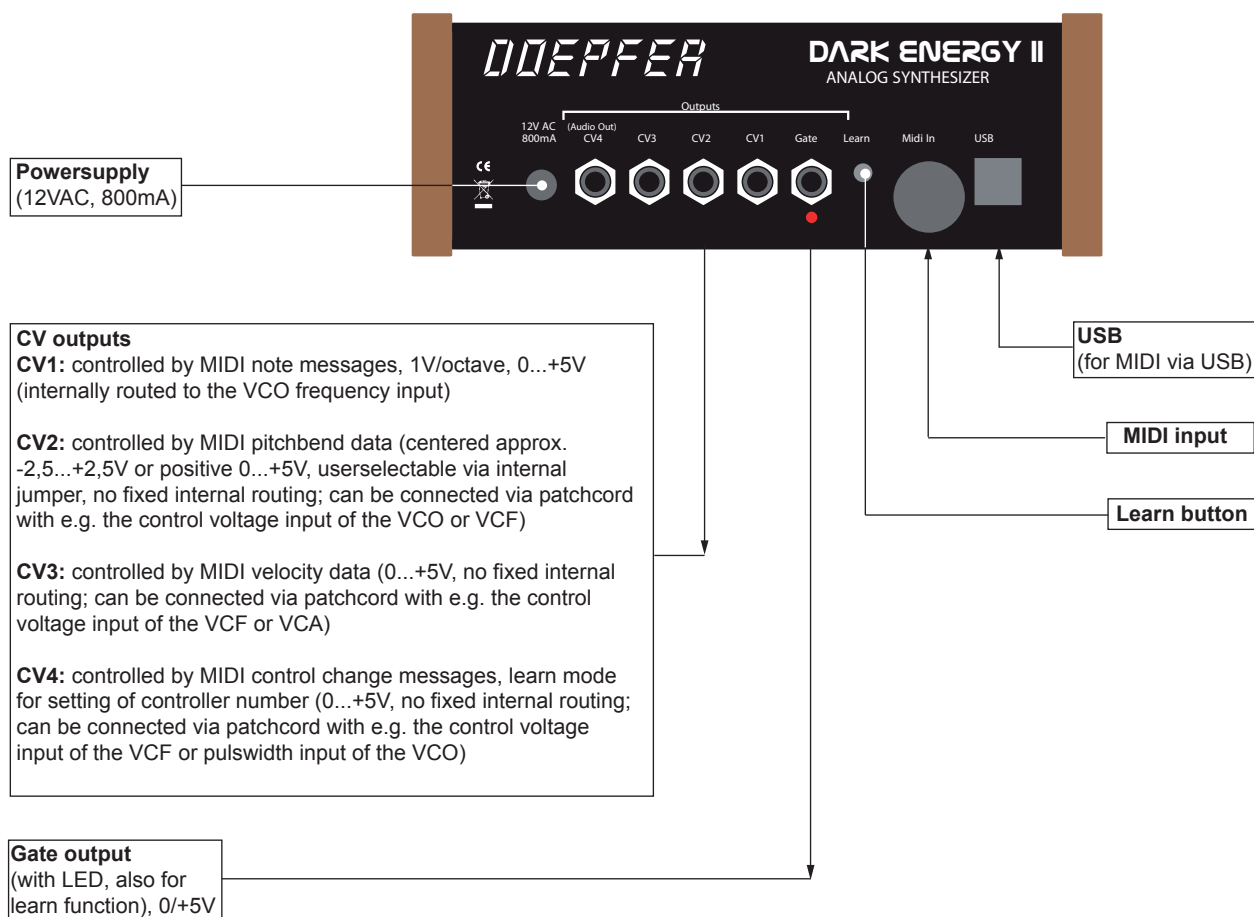

### 3. Functions

In this section, we will explore all of Dark Energy II's modules and functions in detail. We will also have a closer look at the way the modules interact, and finally at MIDI.

#### 3.1. Signal path

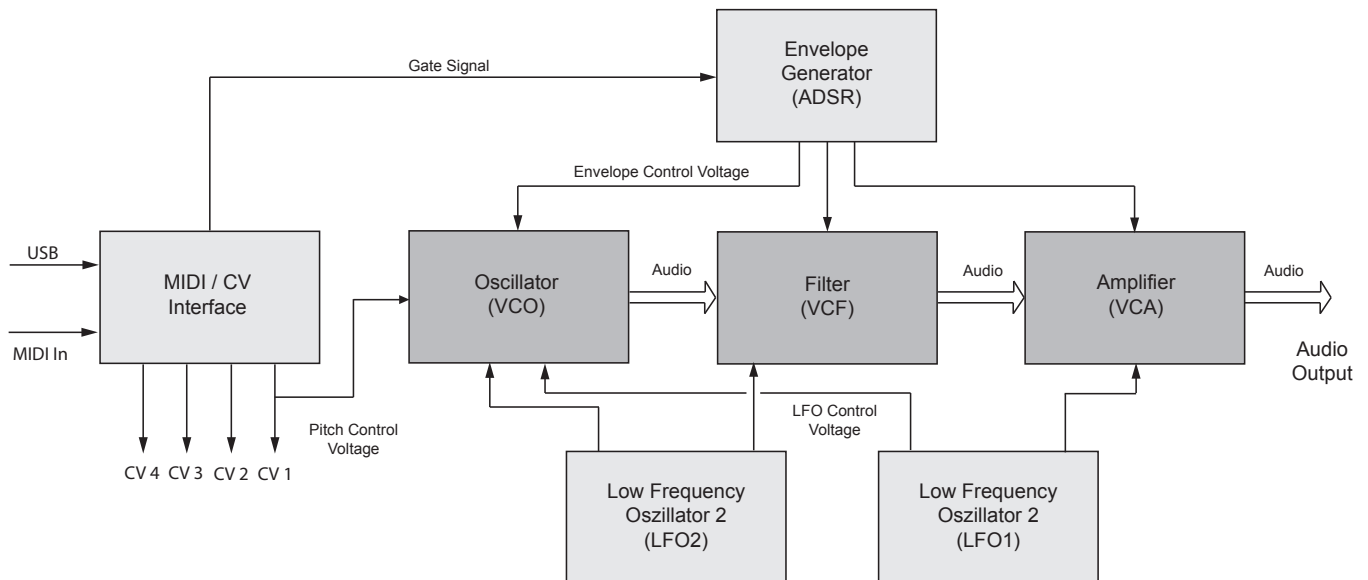

The figure above illustrates an overview of Dark Energy II's signal path.

The dark-grey boxes show all modules that generate or process the sound (or the audio signal, respectively.) They are labelled VCO, VCF, and VCA, and together they form the audio path.

The light-grey boxes are control modules. Instead of audio signals, they generate control voltages which modulate the audio modules. The envelope generator can send control voltages to VCO, VCF, and VCA. The low frequency oscillators (LFO1 and LFO2) can send their control voltages to both oscillators, to the filter (LFO2), or to the amplifier (LFO1) respectively.

The MIDI-to-CV/Gate interface „translates“ incoming MIDI data into control voltages that can be tapped from the sockets labelled CV 1 - 4. CV 1 is also fed into the VCO's input to control the oscillator pitch. Apart from that, the MIDI-to-CV/Gate interface generates a gate signal which triggers the envelope and fires off a tone.

The figure on the following page shows the complete signal path in all its beauty. If you are a bit technically orientated, you will find it easy to follow those tiny electrons through the maze of the circuitry. All inputs and outputs, pots and switches as well as all internal submodules – such as adders and inverters – are shown in the illustration.

The functions of all modules are described in detail in the following section from page 12 onwards. A more general and easy-to-understand description of analog sound generation can be found in section 4, „Nuts and bolts of sound generation“.

# DOEPFER DARK ENERGY II

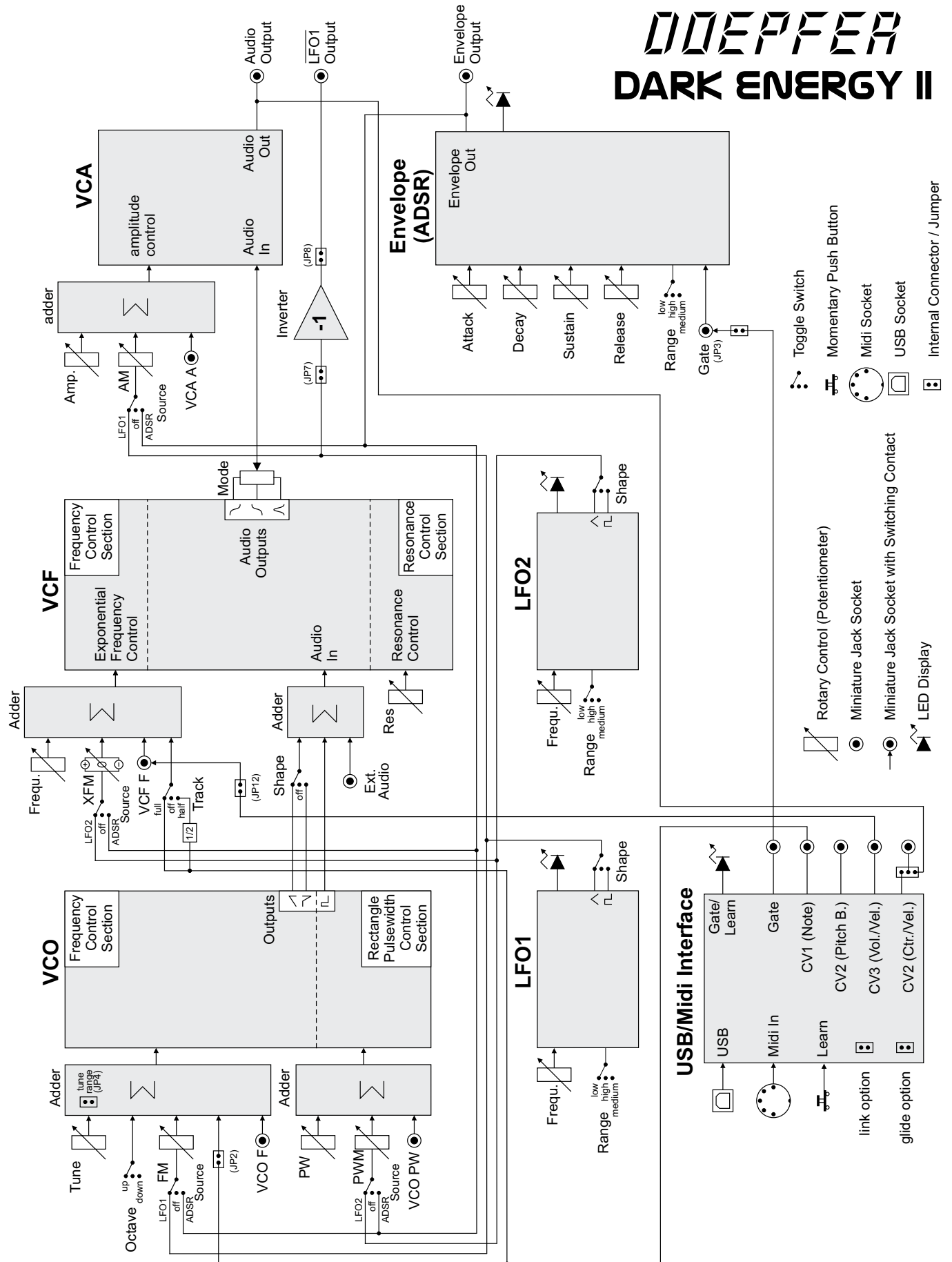

## 3.2. The Modules

### 3.2.1. VCO

The VCO, or alternatively the external audio input, is the source of Dark Energy II's sonic „crude material“. The VCO produces the basic waveforms triangular, sawtooth, and square wave with variable pulsewidth. The module has modulation inputs for frequency (pitch) and pulsewidth. The frequency range covers approx. 10 Hz to 12 kHz.

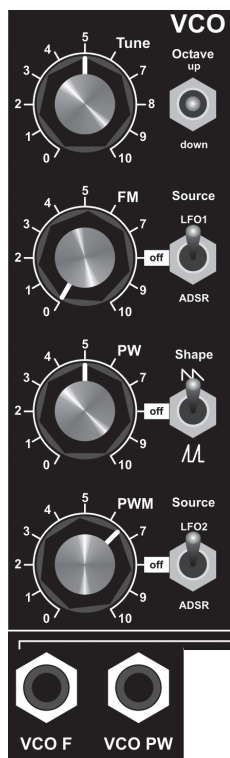

The VCO has the following controls:

- Manual tuning control

This pot is used for sharp or flat fine-tuning of the pitch. An internal jumper selects the range of the pot between approx. +/- 0.5 octave or +/- 2.5 octaves. The default setting is +/- 0.5 octave.

- Range switch -1 / 0 / +1 octave

This switch selects the tuning range.

- FM (frequency modulation) control

This pot is located in the pitch control input section of the VCO. It adjusts the pitch modulation depth of the selected modulation source (LFO1 or ADSR envelope). This pot has exponential response to yield a higher resolution in the lower pitch range.

- FM Source switch

This switch selects the frequency modulation source of the VCO. The choices are LFO1, envelope (ADSR), or no source at all (off). The ADSR generates a „one shot“ pitch contour, which is characteristic of e.g. certain drum- and percussion-sounds. LFO1 produces a periodic and continuous modulation. „Low“ frequency settings of LFO1 will produce vibrato. If LFO1 runs at audio rate (high), the VCO will generate quite noisy textures.

- Manual Pulsewidth control

This pot changes the pulsewidth of the square wave. Altering the symmetry of the waveform from wide to narrow square alters its harmonic content and thus the timbre of the signal. In center position, the VCO produces a rectangular (square) signal (a). Turning clockwise or counter-clockwise respectively first narrows the pulsewidth until, at its most extreme setting, the VCO stops oscillating and no pulse wave signal is audible anymore.

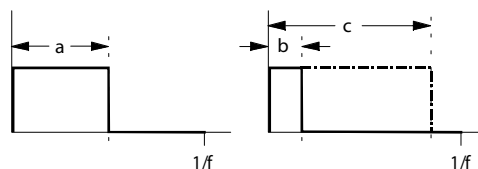

- PWM (Pulsewidth modulation) control

Modulating the pulsewidth creates very interesting textures. This pot is located in the pulsewidth control input section of the VCO. It adjusts the pulsewidth modulation depth of the modulation source selected (LFO2 or ADSR envelope.) At high modulation depths and/or narrow pulsewidth settings (manual pulsewidth control close to fully clockwise / fully counter-clockwise), the modulation depth might exceed the maximum value of the pulsewidth range and the waveform will become inaudible. As a result, you will hear drop-outs in the audio signal. This is perfectly normal and can be used creatively as an interesting „gate“-like effect.

- PWM Source switch

This switch selects the source of the square wave's pulsewidth modulation. The switch toggles between LFO2, envelope (ADSR), and no source (off). The ADSR generates a „one shot“ pulsewidth modulation, LFO2 produces a periodic and continuous modulation. „Low“ LFO2 frequency settings will result in „spacious“ and „lush“ textures which are very useful for huge pad sounds. If LFO2 runs at audio frequency (high), the VCO will generate noisy textures that will be quite different sonically from FM effects.

- Waveform switch (saw / off / clipped and inverted saw)

Apart from the square wave, the VCO also generates two different sawtooth waves. The sum of the square wave signal and the saw waveform, selected by the waveform switch, is fed into the input of the filter. To disable the square wave, turn the PW-control fully clockwise or fully counter-clockwise and shut off PWM by turning the PWM control fully counter-clockwise. Now only the selected sawtooth wave will be audible, depending on the setting of the waveform switch.

To disable the VCO completely, set the waveform switch into off-position, turn the PW control fully clockwise or counter-clockwise, and the PWM control fully counter-clockwise. Use this setting if, for example, you want to feed an external audio signal into the filter of Dark Energy II.

- VCO F Input

Usually, the VCO's internal pitch CV input is connected with the output CV1 of the built-in MIDI/USB interface. This VCO input uses the standard 1volt / octave scaling which is common with most other analog synthesizers. This allows you to play Dark Energy II just like any other keyboard instrument with tempered tuning resp. tuned chromatically. You do not have to scale or tune anything.

In case you want to use Dark Energy without MIDI but connected to a CV/Gate sequencer or a Doepfer A-100 modular synthesizer, you can make use of Dark Energy II's CV inputs. The VCO F socket features an external CV input for VCO frequency (tuning). As soon as you plug a cable in, the VCO's pitch is governed by this input. Please bear in mind that this socket is not normalized. This means that the connection between the MIDI/USB interface and the VCO will not be interrupted when a cable is plugged in. The external CV will be added to the value produced by the MIDI/USB interface. This is very useful e.g. for transposing a sequence which is played on an A-155 step sequencer to a different key in realtime, using a MIDI/USB keyboard.

Instead of a CV/Gate sequencer or a keyboard, you may also use any other suitable CV or even audio signals as a modulation source.

- VCO PW Input

If you wish to control the pulsewidth of the square wave using an external CV, use this input socket. A range of 5 Volts covers the entire modulation range.

If an external control voltage does not comply with the specifications of Dark Energy II's CV inputs (VCO F, VCO PW, VCF F, VCA A, ext. Audio) because it is too high or too low, please use an external attenuator (e.g. Doepfer A-183-1) or amplifier (e.g. Doepfer A-183-3). These additional modules can easily be housed in a Doepfer A-100 Minicase.

### 3.2.2. VCF

Filters are a very important tool on every analog synthesizer. Filters modify sounds by rejecting some frequencies while allowing others to pass in order to tweak the harmonic spectrum of a sound. There are different types of filters. Each one rejects different frequency ranges and therefore has a different effect on the treated sound. Most common and musically most useful filter types are:

- Lowpass: rejects low frequencies and passes high ones.
- Highpass: rejects high frequencies and passes low ones.
- Bandpass: rejects both high and low frequencies and passes a certain frequency band.
- Notch: rejects a frequency band and generates a "notch".

Dark Energy II uses a multimode filter that is capable of generating all four types of filter characteristics. Continuous crossfading between the types is possible.

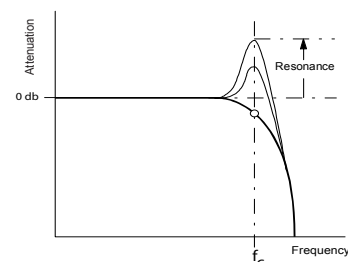
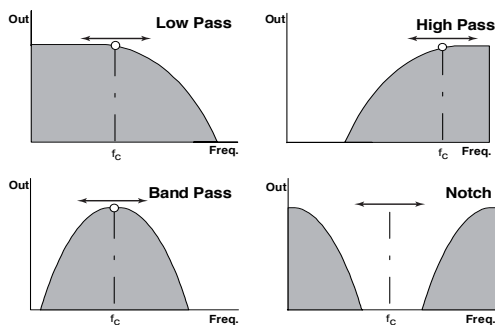

The resonance characteristics of a lowpass filter

The frequency rejection of all filter types has a certain strength ("quality"). The frequency where the rejection starts is called "cutoff frequency" (for high- and lowpass) or "center frequency" (for bandpass and notch). This point can be controlled by a pot or modulated by a control voltage in order to achieve dynamic timbral shifts.

Another important filter term is „resonance“. Filter resonance emphasizes the harmonics around the cutoff / center frequency point. The sound will become increasingly „sharper“ and „edgier“. At a certain level, the filter will start to self-oscillate and generate a waveform close to a sine wave. Dark Energy II's VCF can also be driven into self-oscillation in order to use it as an additional signal source for certain popular sound effects which are immediately recognizable as „typically synthesizer“.

The VCF gives you the following controls:



- Manual frequency control (Freq.)

This pot allows you to control the cutoff / center frequency of the VCF manually. In other words, it is up to you to „open“ and „shut“ the „window“ of the filter (low- and highpass) or „shift“ it up and down the frequency range (notch and bandpass). Turned fully clockwise, the filter will be opened completely and the entire frequency range of the incoming signal can pass. Depending on the filter mode (see below) the Freq-knob acts differently: Turned fully counter-clockwise, the lowpass filter will be closed to an extent that all audible frequencies will be rejected and no output signal will be audible. The highpass works vice versa. The further this knob is turned clockwise, the lesser the effect of the envelope (ADSR) on the sound will be. Bandpass and notch will not be opened or closed but will pass different frequency ranges. The entire frequency range of Dark Energy II's filter covers approx. 12 octaves.

- XFM control

In order to achieve dynamic and periodic changes of timbre, the cutoff frequency can be modulated by control voltages. The XFM knob determines the modulation depth. Set fully counter-clockwise, no modulation will appear, while turned fully clockwise means maximum modulation depth. The modulation depth will be added to the setting of the manual frequency knob. Since the sum of both cannot exceed the maximum value of the cutoff parameter range, the setting of the „Freq.“ pot influences

the modulation depth: The higher its set value, the less the effect of the XFM knob on the sound. The XFM function uses exponential frequency modulation.

In some cases, FM has to be controlled and used in a very subtle way, especially when the filter is self-oscillating (that is, working as a sinewave oscillator) and modulated by LFO2 at audio rate. In order to optimize parameter scaling, the XFM control works in an exponential way. Thus, audible modulation might require settings above „5“, especially when using the ADSR as a modulation source.

- XFM Source switch

This switch selects which source is to modulate the cutoff frequency exponentially. The switch toggles between LFO2, envelope (ADSR) and no source (off). Controlling the cutoff frequency by the ADSR is one of the most common applications as it imitates the typical timbral characteristics of most acoustic instruments from bright- to dull-sounding. Of course, Dark Energy II's envelope generator allows many more ways of shaping timbre.

LFO2 produces a periodic and continuous modulation signal. Low frequencies will create sweeps similar to a „wah-wah“ pedal as used by guitarists. Using the LFO's „high“ range setting, XFM will generate very noisy sounds that cannot really be played tonally. This way of modulation is great for unique and interesting „outer space type“ sound effects. Feel free to experiment with the settings of cutoff frequency, LFO2 speed and XFM pot, and keep watching the skies while you are at it.

- Mode control

This knob crossfades continuously between the different filter types. Turned fully counterclockwise, a 12 dB lowpass is generated. By turning clockwise, the characteristics change to notch, further on to a 12 dB high-pass (approx. at center position) and finally to a bandpass (close to fully clockwise position).

- Resonance control (Res)

This pot determines the intensity of the filter resonance. This effect depends a lot on the cutoff and mode settings. At high resonance settings, the filter will start resonating and will generate a waveform close to a sine wave. It can be used as an additional signal source to produce popular sound effects, e.g. typical synthesizer percussion sounds when the cutoff is modulated by a suitable ADSR setting. Think disco hits ca. 1975 and you will get an idea.

When the filter is self-oscillating (high resonance) and the VCO is disabled (waveform switch at center position and PW pot turned fully clockwise or counter-clockwise), the filter will work as a sinewave oscillator. It can be modulated by LFO2 (exponential FM).

- Tracking switch

The tracking switch has the positions „half / off / full“. It determines whether or how much the filter cutoff frequency will depend on the pitch of the played key (resp. VCO pitch). When set to „full“, higher notes will sound increasingly brighter, lower notes the duller the deeper you go on the keyboard. This corresponds to the typical character of acoustic instruments. When set to „half“, this effect is less intense. If the filter is self-oscillating and is to be played tonally as an oscillator from a MIDI keyboard, this switch has to be set to „full“. This way it receives the same control voltage as the VCO.

- VCF F Input

Please use this socket if you want to modulate the filter cutoff frequency by an external control voltage or an external audio signal. This input also uses an (exponential) 1V/Oct scaling. This way the self-oscillating VCF can be played (almost) chromatically (the scaling is not as precise as the VCO scaling due to technical reasons but much better than found on many other analog synthesizers.) The control voltage fed into this input will be added to the internal CVs (Freq. knob, tracking switch, XFM knob.) Please bear in mind that the sum of these CVs cannot exceed the maximum value of the modulation depth range.

- Ext. Audio Input

It can be very interesting and musically useful to process external audio signals, such as acoustic instruments, drum loops or even complete tracks, with the components of a synthesizer. You guessed it – Dark Energy II offers an input socket for external audio signals which can be used as a sound source in addition

to the VCO signals. Signals connected to this socket are fed directly into the filter. The input is mono and will process levels up to 1Vpp without distortion.

When using an external audio signal please note: Set the waveform switch to „off“ (center position), turn the PW pot fully clockwise or counter-clockwise and shut off PWM by turning the PWM pot fully counter-clockwise if you want the VCO to shut up completely. To make a connected audio signal audible, Dark Energy II's VCA has to be opened. Turn up the VCA pot and / or play a note on your keyboard which will open up the VCA via a gate signal and ADSR control voltage. Of course you can use the external input and the VCO in parallel. This way you may add a second VCO (e.g. Doepfer A-110, controlled from the CV1 socket) or a noise generator (e.g. Doepfer A-117 or A-118) as an additional sound source.

### 3.2.3. VCA

The VCA produces dynamic control over a third important parameter - loudness or volume. A VCA is a voltage-controlled amplifier. Dark Energy II uses a VCA with exponential character.

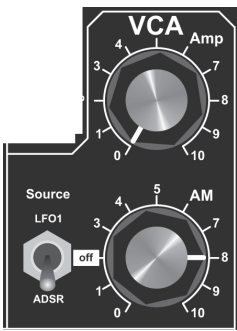

The VCA has the following controls:

- Amplitude control

This pot controls the level of the output signal initially independently from the ADSR / LFO1 controls. If only this knob is cranked up, you will hear a static tone which is not influenced by the envelope or LFO1 settings.

- AM knob (amplitude modulation)

This pot adjusts the depth of loudness modulation by a selected modulation source (LFO1 or envelope/ADSR). Please note: Above the center position the modulation depth decreases again. The highest output level with maximum dynamics can be achieved in settings around the center position. The reason for this effect is quite simple: The maximum amplification factor of the VCA is „1“. The AM knob value is added to the amplitude knob value. If the sum of the control voltages is bigger than „1“, they will get „compressed“ or „flattened“. This will result in a new and different envelope- or LFO shape with reduced dynamics and – if LFO1 is selected as modulation source and AM knob is set above 7-8 – in a trapezoid-shape voltage contour. To achieve a symmetrical LFO modulation, the amplitude knob should be around its center setting. So, next to the modulation intensity, the VCA knobs can also be „abused“ to shape the modulation curve to a certain degree.

- AM Source switch

This switch selects the source of the VCA's amplitude modulation. The switch toggles between LFO1, envelope (ADSR) and no source (off). The ADSR as AM source produces a „one shot“ loudness contour. This modulation – do you remember the filter section? - is one of the most important standards in sound synthesis as it simulates the typical characteristics of the loudness contour of acoustic instruments from loud to soft. LFO1 again generates periodic modulation. Low LFO1 frequency settings will result in tremolo. If LFO1 runs at audio rate (high), AM will generate noisy textures not unlike distortion.

- VCA Input

This socket delivers an input for external CVs to control the VCA amplitude with. This external CV will be added to the internal CVs provided by LFO1 /ADSR. The external CV is added behind the AM-knob. This input processes signal levels between 0 Volt and +5 Volts.

- Audio Output

This is where you can tap Dark Energy II's output signal from. Maximum level is approx. 1 Vpp.



Up to this point we have studied modules that generate or process the audio signal itself. The following modules generate control voltages in order to modulate the sound-shaping parameters of VCO, VCF and VCA in a dynamic way.

### 3.2.4. ADSR

Dark Energy II's envelope generator (or „ADSR“) produces a sequence of four control voltages every time a key on a connected keyboard is depressed, or when Dark Energy II generates or receives a MIDI note-on command or a gate signal. The envelope's control voltages are used to give the sound a dynamic shape.

The envelope produces four parameters:

- Attack
- Decay
- Sustain
- Release

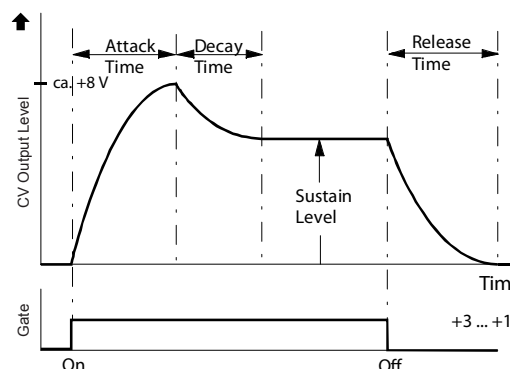

As soon as the envelope generator receives a gate-on signal, its output CV will rise from 0 Volt to maximum. The rise time is adjustable and called „Attack“. When the maximum value has been reached, the voltage will drop within a timespan defined by the „Decay“ pot to the „Sustain“ level. The envelope control voltage will stay on this level until the key is released, then it will drop to 0 Volt within the „Release“ time dialled up.

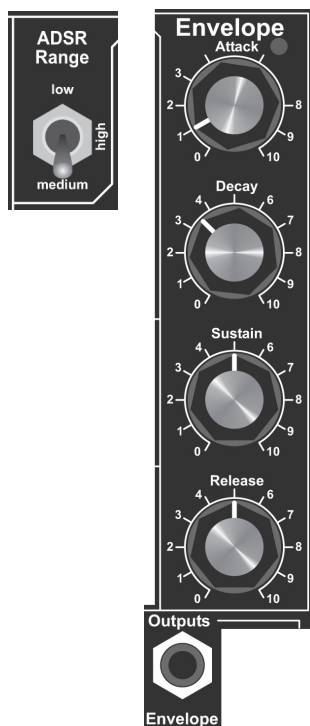

The envelope generator features the following controls:

- controls for Attack, Decay, Sustain and Release. Please bear in mind that Attack, Decay, and Release determine periods of time while Sustain is a level value.
- ADSR Range switch  
This switch offers three different ranges (long / short / medium) for the time-related parameters Attack, Decay and Release. Use „short“ for extremely percussive sounds, „long“ is most useful for slowly evolving pads, medium for everything else in between.
- A blue-colored LED indicates the status of the envelope generator.
- Gate Input socket (back panel)  
Instead of the internal gate signal, derived from an incoming MIDI note, the envelope generator can also be triggered by an external gate signal via this socket (0/+5 to +12V). Use this socket if you wish to control Dark Energy II from a CV/ Gate sequencer or keyboard.
- Envelope Output socket  
From this socket the control voltage generated by the envelope generator can be tapped and used for additional modulation purposes.

### 3.2.5. LFO1 and LFO2

A Low Frequency Oscillator produces a signal, mostly in the sub-audio range, which can be used to generate periodic changes of several patch parameters. Dark Energy II features two identical LFOs.

The LFOs boast the following controls:



- Frequency control

This pot controls the LFO frequency, that means, the modulation rate.

- LFO range switch

This switch offers three different ranges for the LFO frequency: „Low“ (periods of up to a minute) / „Audio“ (above 5 kHz) / „Medium“ (usual LFO range - several seconds up to some 10 Hertz or more).

Since Dark Energy II's LFOs produce frequencies up to audio range, they can be used to generate FM-effects with VCO pitch, VCO pulsewidth and VCF frequency as well as AM-effects (VCA). Use this function to create complex timbres or more abstract sound effects.

- Dual-colored LEDs (yellow/red) indicate positive and negative status. At frequencies higher than approx. 30 Hz, the LEDs will be lit orange.

- Waveform switch

This switch selects the waveform of the LFO signal (triangle / off / square) or shuts the LFO off. Triangular is ideal for soft modulations, square generates „trills“ in pitch or filter frequency.

- LFO1 Output socket

The inverted output signal of LFO1 is available from this socket. You may use it for additional modulation routings.

Internal jumpers deliver the non-inverted signal of LFO1 or the ADSR control voltage at this socket. You can configure this jumper to your needs, but please keep in mind that opening Dark Energy II's casing needs some basic skills in handiwork. If you feel unable to do this, please get in touch with Doepfer anytime (during office hours, preferably).

You will find some more information in section 3.5, „Modifications“, on page 25.

### 3.3. USB/MIDI Interface

#### 3.3.1. Connection / MIDI channel

Quite likely, you want to play your Dark Energy II via MIDI - there are two easy ways to do so:

- MIDI via USB or
- the „traditional“ MIDI-connection via DIN socket.

• *USB*: To hook up Dark Energy II in your MIDI-setup via USB, simply connect the included USB cable with Dark Energy II and with an unused USB port on your Mac or Windows PC.

Mac OSX, Windows XP (SP2 or higher), and Windows Vista offer the necessary drivers and Dark Energy II will be mounted as soon as it has been connected. You will find a new MIDI port in your MIDI application, named „USB audio device“ (Windows XP) or „Dark Energy II“ (OSX, Windows Vista), and you are ready to go.

If this message is missing or an error message is shown, e.g. „USB device not found“, the necessary driver has most likely not been installed or is not working properly on this computer. In this case, Dark Energy II's USB port unfortunately cannot be used on this specific computer. We apologize for not being able to support this particular problem as there can be various reasons for that misbehavior which are very specific and depend on the individual computer. Of course, you can run Dark Energy II via the MIDI DIN-connection in such a case without any problems. The same goes for an older system based on Windows or Mac that does not provide you with the necessary drivers.

• *DIN socket*: You may alternatively connect Dark Energy II via MIDI cable to a MIDI interface, a MIDI keyboard, or a MIDI hardware sequencer. Simply connect the MIDI output of your MIDI device with Dark Energy II's MIDI port. Please do not use USB and DIN connections simultaneously.

• MIDI channel selection (Learn button):

In order to enable Dark Energy II to receive incoming MIDI messages, the MIDI channel of both the MIDI device and Dark Energy II have to be identical. This is how you can select Dark Energy II's MIDI channel:

- Select the desired MIDI channel on your MIDI device / software application. Please refer to their respective user manuals when in doubt.
- Press the „Learn“ button on the back of Dark Energy II and keep it depressed for at least one second.

The LED will start flashing, showing that Dark Energy II is in „learn mode“. The delay of one second avoids accidental use of the „learn“ mode. The flashing LED always indicates Dark Energy II's active learn mode. For easy access to the „learn“ button you can use a pen or a plug.

- Press the key on your keyboard with the lowest key that Dark Energy II is supposed to play. This key will set CV1 (pitch CV) to 0 Volt. This is approx. equivalent to 65 Hz / „C“, when tuning control and range switch are both in their center position. The available range will cover five octaves above that key. The default setting is MIDI note number 36.
- Now you're done - Dark Energy II's MIDI channel will now correspond to the one of the connected MIDI device. Dark Energy II will quit learn mode automatically and return to normal running mode. If you enable „learn“ mode accidentally, simply hit the „learn“ button again to quit.

When Dark Energy II receives a MIDI note, the „learn“ LED will turn off briefly. You may use this as a MIDI-

in monitor, without the need to connect a sound system.

### 3.3.2. MIDI to CV/Gate interface

Since Dark Energy II's sound generation works entirely analog, and „real“ analog control voltages and gate signals are used internally, the unit features a complete USB/MIDI-to-CV/Gate interface.

This integrated „USB/MIDI-to-CV/Gate“ interface generates not only a pitch control voltage and a gate signal to trigger the envelope with, it also produces several control voltages derived from incoming MIDI velocity and MIDI controller data. The MIDI-to-CV interface also features a simple but useful arpeggiator and a so-called reference pitch. You have encountered the reference tone before when you selected the MIDI channel - it was the MIDI note that set Dark Energy II's pitch CV1 to 0 Volts and thus became the lowest key of Dark Energy II's key range.

All CVs and gate signals can be tapped from sockets on the back of Dark Energy II. Use patch cords to connect them with the module inputs on Dark Energy II's frontpanel. This way you can control the most important sound parameters dynamically via MIDI velocity and a MIDI controller.

You may „abuse“ Dark Energy II's MIDI-to-CV/gate interface to control another, not MIDIified analog synthe-

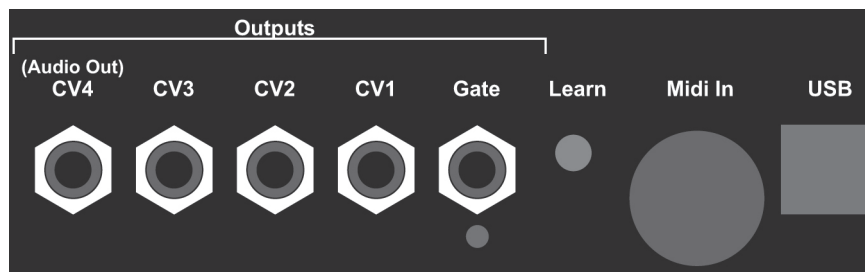

size that complies with the specifications of Dark Energy II.

Depending on the incoming MIDI data (note on/off, notenumber, pitch bend, MIDI controller, velocity), the interface will generate:

- The gate signal for the envelope generator,
- CV1: controlled by MIDI note numbers; 1V/oct scaling (internally connected to the VCO's pitch control input)
- CV2: controlled by MIDI pitch bend data (ranges approx.  $-2.5V$  to  $+2.5V$  or  $0V$  to  $+5V$ , selectable via internal jumper). CV2 has no internal connection, it can be patched into the control inputs on Dark Energy II's frontpanel as desired.
- CV3: controlled by volume or the sum of volume and velocity (selectable via learn mode). CV3 has no internal connection, it can be patched into the control inputs on Dark Energy II's frontpanel as desired. Please refer to page 20, section (2).
- CV4: controlled by a freely selectable MIDI controller or the product of controller data and velocity (controller number selectable via learn mode). CV4 has no internal connection, it can also be patched into the control inputs on Dark Energy II's frontpanel as desired. Please refer to page 20, section (2).

By changing an internal jumper, the CV4 socket can become a second audio output. In this case, CV4 is not available anymore. This mod allows you to use Dark Energy II without any cable plugged into the frontpanel. The default setting is CV4.

### 3.3.3. Learn Mode / MIDI Functions

In „learn“ mode you will determine how Dark Energy II will process incoming MIDI data. In addition to this, you will control the settings of the internal arpeggiator and set the reference tone which will determine the lowest key of Dark Energy II's keyboard range.

You can access each function via MIDI program changes. The table below lists all functions. The notes (1) to (10) explain all functions in detail.

Function	MIDI-Message	Count 1-128	Count 0-127	Note	Short Explanation
MIDI-Channel/Reference note (CV1=0V)	Note on			(1)	
CV3 Velocity off	Program Change	#1	0	(2)	CV3=Volume
CV3 Velocity on	Program Change	#2	1	(2)	CV3=Volume*Velocity
CV4 Velocity off	Program Change	#3	2	(2)	CV4=Ctr.X
CV4 Velocity on	Program Change	#4	3	(2)	CV4=Ctr.X*Velocity
<b>Retrigger</b>					
Off	Program Change	#5	4	(3)	
On	Program Change	#6	5	(3)	
<b>Key-Assign-Mode</b>					
Highest note	Program Change	#15	14	(6)	
Last note	Program Change	#16	15	(6)	
Reference note	Program Change	#17	16	(6)	
Stack note	Program Change	#18	17	(6)	
Arp. Mode On/Off	Program Change	#19	18	(7)	Arpeggiator
Arp. Mode Hold	Program Change	#20	19	(7)	Arpeggiator
Arp. Mode Overwrite	Program Change	#21	20	(7)	Arpeggiator
Arpeggiator Sync - Internal	Program Change	#22	21	(8)	Tempo - internal
Arpeggiator Sync – External (MIDI Realtime/Clock)	Program Change	#23	22	(9)	Tempo - external
Controller for CV4	Free MIDI-Controller (not Bank Change-Controller Ctrl-0/32)			(10)	

#### Notes:

(1) MIDI channel/reference for CV1=0V

In case of an incoming note event in learn mode, the note number and the channel of the event will be taken as the new reference tone and MIDI channel of Dark Energy II. The reference key will be the MIDI note number that is assigned to 0V CV1 output. In practice you simply enter the learn mode and press the key on your MIDI keyboard that is supposed to be 0V CV1. MIDI note events below the reference note or higher than 5 octaves above the reference note will be ignored as the CV1 voltage range of Dark Energy II is 0...+5V. The factory default settings of reference key and MIDI channel are note number 36 (C) and channel 1.

For setting these parameters, MIDI Program Change messages coming from your MIDI device are used. Normally, you will have to press the program change keys on your MIDI keyboard or MIDI synthesizer while in „learn“ mode. Bear in mind that some manufacturers count the MIDI program change numbers from 0 to 127 rather than from 1 to 128 as defined by the MIDI standard. If the lowest program change number you can send with your MIDI device is 0 (zero), you have to subtract 1 from the program change numbers in the table above because in this case the program changes of your device range from 0 to 127 instead of 1 to 128. For some devices (especially software sequencers) the type of program change numbering can be selected. In this case you should use the 1 to 128 range to comply with the numbers in the table above.

The program change messages must be sent on Dark Energy II's MIDI channel (please refer to section „MIDI channel selection / learn mode“ on page 19).

## (2) Velocity on/off

These program-change messages are used to select whether the note-on velocity affects the control voltages CV3 and / or CV4. If velocity is „off“, only volume (CV3) respectively the unassigned controller (CV4) is used to generate the control voltage. If velocity is „on“, the volume or controller value is multiplied with the note-on velocity, i.e. the CV value changes with every new note event as the velocity of the note event is used to calculate the control voltage together the volume message (CV3) resp. the unassigned controller (CV4).

## (3) Retrigger on/off

With this parameter you can select whether a new gate/trigger pulse is generated when playing legato (i.e. playing a new key on the keyboard without releasing the key played previously). The factory default setting is „retrigger off“. Additionally, the MIDI controllers legato (controller #68) and sustain (controller #64) affect the gate output in the usual way.

## (6) CV1 Key Assign Mode (Note Priority)

These program change messages adjust the type of assign modes for CV1.

- If „*highest note*“ is selected, the highest key pressed on the MIDI keyboard is used to calculate CV1 if more than one key is being held.
- In the „*last note mode*“ always the last note played (chronologically) is taken as CV1. „Reference note“ means that only the reference note is accepted. This feature is useful if you want to trigger different devices from the same MIDI channel using two or more Dark Energies. In this case you have to set the reference keys for each Dark Energy II unit to a different value.
- „*Stack note*“ means that Dark Energy II will sort out the note event that is used by Dark Energy II to generate

CV1. The note event in question will not be transmitted to the (internal) MIDI Thru output of the interface.

Stack mode is used to control more than one synthesizer via the same MIDI channel and allows polyphonic control of different synthesizers from the same MIDI channel.

Please note that using this mode needs the internal Link-interface of Dark Energy II which is only accessible via an internal hardware modification. Please refer to page 25 for further information.

## (7) Arpeggiator

Dark Energy II features an internal arpeggiator. An arpeggiator splits the notes of a sustained chord into a successive pattern of single notes. In music, splitting chords into a pattern of successive pitches is generally called „arpeggio“. Dark Energy II's arpeggiator makes use of the following parameters:

- *Tempo* of the arpeggio can be determined by Dark Energy II itself or synced to an external MIDI device.
- *Direction* is defined by the order in which the keys have been played on the keyboard.
- *Playback Mode*:
  - On/off: Enables the arpeggiator. Set to „on“, a key has to be depressed to become part of the arpeggio. As soon as a key is released, the note will be deleted from the arpeggio pattern. In other words: Only sustained keys will be played back as an arpeggio.
  - Hold: In contrast to the „On“ mode, notes will still be played back after the corresponding key has been released. The notes will be deleted from the pattern as soon as they are played a second time. Imagine this function was a „toggle switch“.
  - Overwrite: Again, the notes will be played back in the same order in which they have been played on the keyboard. After the sixth note (maximum capacity), the arpeggio will start all over again. This mode will „collect“ played keys, deleting notes selectively is not possible. The entire pattern will be deleted when the arpeggiator is stopped.

#### (8) Arpeggiator Sync - internal

Dark Energy II's arpeggiator generates its own clock signal. The tempo can be controlled via MIDI Modwheel data. Since a modwheel can be found on almost every MIDI keyboard, it is a useful controller to set the tempo of the arpeggiator in realtime (see below).

#### (9) Arpeggiator Sync - external (MIDI clock)

The arpeggiator receives tempo data from an external device via the USB/MIDI input. It will process the so-called MIDI realtime events: MIDI Start, Stop, Continue, Clock.

Please note: The arpeggiator will run only if these events are generated and sent by the master MIDI device!

The following realtime parameters can be controlled by several MIDI controller messages (these parameters cannot be saved. After powering down/up Dark Energy II, they will return to their default settings).

- *Tempo*
  - MIDI controller 1 (Modwheel)
  - Value range: 0 - 127
  - Value 0 = Stop
- *Gate length (note length)*
  - MIDI controller # 0
  - Value range: 0 - 127
  - (Divides the MIDI-clock value or the value of the internal clock. Divider is 1/96.)
- *Octave*
  - MIDI controller # 0
  - Value range: 0 - 6
  - (The pattern will be transposed up to 7 octaves, until it starts again with note „one“.)
  - Since Dark Energy II's note range covers a maximum of 5 octaves, higher notes will be ignored and produce „pauses“ within the pattern. This effect can be used in a creative way to create musical phrases.
  - Example:* With the setting „octave 1“, the played chord A3-C4-F4-G4 will produce exactly the same pattern. Using „octave 2“ instead results in the pattern A3, C4, F4, G4, A4, F5, G5 and so on.

#### (10) MIDI controller for CV4

If Dark Energy II receives a MIDI controller message (except bank controller # 0 and # 32) while in „learn mode“, the controller number of this message will define the controller number for CV4, for instance, the CV4 output of Dark Energy II will correspond to this controller number from now on. The controller message must be sent on Dark Energy II's MIDI channel (see section „MIDI channel / Learn mode“ on page 17). Controller # 0 and # 32 (Bank Change) will be ignored and cannot be „learned“.

Whenever Dark Energy II receives one of the MIDI messages listed in the table above, the parameter in question will be changed and Dark Energy II will return to normal play mode, i.e. the LED will stop flashing. Make sure that no accidental MIDI messages appear while in learn mode (e.g. from a sequencer) as you alter the settings of Dark Energy II by such MIDI messages. All parameter changes made while in learn mode are stored in Dark Energy II's non-volatile parameter memory. When Dark Energy II is turned on next time, the parameter settings will be loaded from this memory.

### 3.3.4. Resetting Dark Energy II

In order to return to the factory settings of all parameters, you have to reset the device. This might be useful if, for instance, you do not remember the last parameter settings (e.g. MIDI channel, reference note, controller # for CV4, key assign mode) or if they are out of alignment. If your Dark Energy II seems to behave in strange ways and you do not know how to solve the problem, resetting the device may help as the values of all parameters will be restored after the reset.

To reset the device, depress and hold the learn button while the power supply is plugged in. The LED will light up and you have to keep the button depressed for a few seconds until the LED starts flashing. Pressing the button again gets you back into normal operation mode and the LED will turn on. After resetting, Dark Energy II's parameters are set to the following default values:

- MIDI channel 1
- Reference note 36 (i.e. the lowest „C“ on a standard 5-octave keyboard)
- Retrigger: on
- CV3: volume (controller #7)
- CV4: modulation (controller #1)
- Key assign mode: highest note
- Internal Arp-Tempo: approx. 120 BPM
- Gate length: 6
- Octave: 1
- Arpeggiator Sync: internal

These values are identical with the factory default settings.



### 3.4. Linking / stacking several Dark Energies

In parallel, using the same MIDI channel:

You may run several Dark Energy IIs in parallel. When all devices use the same MIDI channel, they will all sound simultaneously when a note is played. Stacking Dark Energies this way may create even more complex and richer sounds. It is also interesting to program only slight timbral differences between the units. This can be useful for very expressive and rich sounds. The easiest way of stacking Dark Energies is accomplished by using a MIDI-THRU box, a MIDI interface with multiple outs, or a USB hub.

Stack Mode:

Stack Mode (p. 19, 20) drives several Dark Energies like one single polyphonic instrument. Every unit plays one voice. Since the casing of Dark Energy II is too tightly-packed, it has no MIDI-THRU socket but an internal link connector. Holes in the sides of the box give access to these connectors as soon as the wooden cheeks have been removed. You can bolt several units together side by side.

The use of these internal link-connectors requires some hardware modifications which are described in an additional technical documentation of Dark Energy II. Please download this documentation from our website:

[www.doepfer.de](http://www.doepfer.de) -> Products -> Dark Energy II -> Additional technical documentation

***Important: Please do not tinker around with your Dark Energy II without having read and fully understood this additional technical documentation! Otherwise you may damage your instrument, void its warranty, risk your mental health. Don't ever do that!***

### 3.5. Modifications

Dark Energy II allows various hardware modifications to customize the unit to your specific needs. Apart from the Link-connection (see above), there is the configuration of the CV output sockets, and the alignment of some parameters. Furthermore, you can bolt the casings of several units together in order to get one big and even „darker“ Energy. Darth Vader will be very jealous.

All this is described in detail in the additional technical documentation of Dark Energy II. Please download this documentation from our website:

[www.doepfer.de](http://www.doepfer.de) -> Products -> Dark Energy II -> Additional technical documentation

***Once more: Please do not tinker around with your Dark Energy II without having read and fully understood this additional technical documentation! Otherwise you may damage your instrument, void its warranty etc. Don't say we didn't warn you!***

If you believe yourself to be technically totally inept, you may as well have these modifications done by a capable, qualified, and authorised tech. You will find all information necessary on our website ([www.doepfer.de](http://www.doepfer.de)). Always a good browse, by the way!

### 3.6. Firmware Update

Dark Energy II's firmware can easily be updated via USB. In case a new firmware version is available, you can download it from our website ([www.doepfer.de](http://www.doepfer.de)). A detailed description of the update process can be found in the additional technical description of Dark Energy II. You can download this documentation here:

[www.doepfer.de](http://www.doepfer.de) -> Products -> Dark Energy II -> Additional technical documentation

## 4. Nuts and bolts of sound generation

In case analog synthesizers – or synthesizers in general – are new to you, please read this section thoroughly. You will learn about the nuts and bolts of analog / subtractive synthesis that will help you to fully grasp Dark Energy II's little secrets.

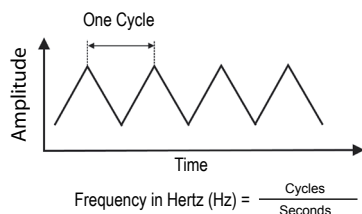

**Sound** is, very generally speaking, a change in air pressure. If these changes occur continuously and at a certain frequency, they can become an audible noise or tone. Frequency is measured in Hertz (Hz). The human ear can perceive frequencies from about 20 Hz to 20,000 Hz. The frequency of an audible signal determines its musical **pitch**.

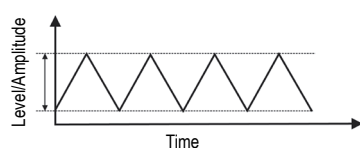

Another fundamental parameter that is perceived by our ears is **loudness**, that is the level of an audible signal. Loud noises shift more air than soft ones. Thus, the “size” of the signal is called amplitude and is measured in Decibels (dB).

The third important parameter which defines a sound is **timbre**. There is no specific definition as such, it is usually described in terms like “sharp”, “dull”, “bright”, “dark”, “thin”, or “rich”.

Timbre is determined by the so-called harmonic spectrum of the sound. In general, bright sounds contain more harmonics, dull sounds less.

As we will see, the “crude material” of a sound is defined by three parameters, namely frequency, amplitude, and timbre.

### Oscillators and Waveforms

On analog synthesizers, the timbral “crude material” is produced by voltage-controlled oscillators (VCOs). Normally, a VCO creates waveforms with varying overtone spectra. Standard waveforms are pulse, sawtooth and triangular. These are most useful in sound synthesis as they each offer a rich but different harmonic spectrum, and therefore they sound very different from each other. That is why Dark Energy II makes use of them. Less useful waveforms (sine, spaced sawtooth, graphically editable waveforms) will not be discussed here, let alone, used.

As mentioned above, waveforms differ in their harmonic spectrum, i.e. they contain different harmonics. An overtone is called “harmonic” if its frequency is a proper multiple (2, 3, 4, ...) of the fundamental frequency.

A sawtooth wave contains all harmonics with descending amplitudes. Dark Energy II's oscillator generates two different sounding types of saw waveforms.

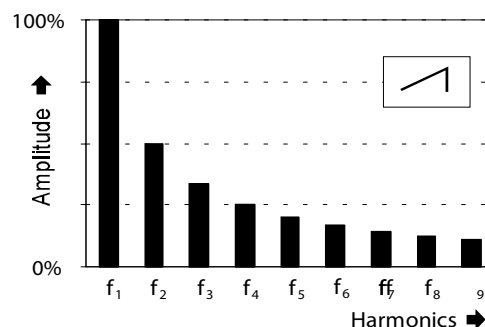

The symmetrical **pulse wave** (or “**square wave**”, pulsewidth = 50 %) contains odd harmonics only (see Fig.). An asymmetrical pulsewave (often simply called “pulse wave”) contains all harmonics with their amplitudes depending on the pulsewidth.

The more the pulsewidth deviates from the symmetrical 50 %, the stronger the higher harmonics will influence the sound, i.e. its timbre will become more “nasal”.

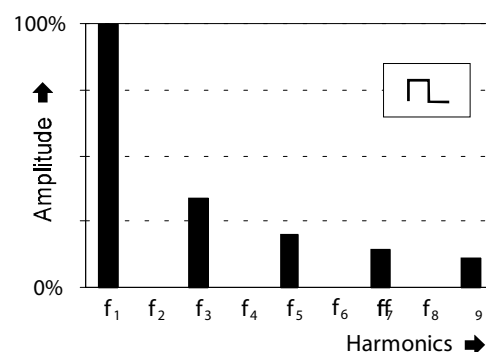

The **width of a pulse wave** can be modulated by a low frequency oscillator (LFO) or, less common, by an envelope generator. This way the harmonic spectrum of the pulse wave does not remain static. The resulting sound is similar to the chorusing effect between two oscillators which are nearly perfectly in tune, i. e. unison. The modulation frequency has to be very low (approx. 1 Hz or lower) because otherwise the oscillator will sound out of tune.

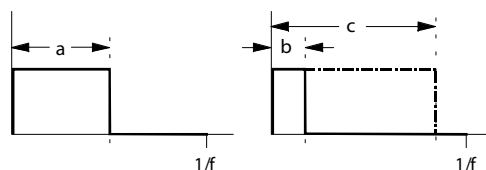

The **triangular** and sine waveforms have only a shallow harmonic structure or, as in the case of the sine wave, no harmonics at all. The triangular waveform contains only odd harmonics like the sawtooth, but their amplitudes decrease by the factor two. With the sawtooth wave, these overtones decrease in a linear fashion.

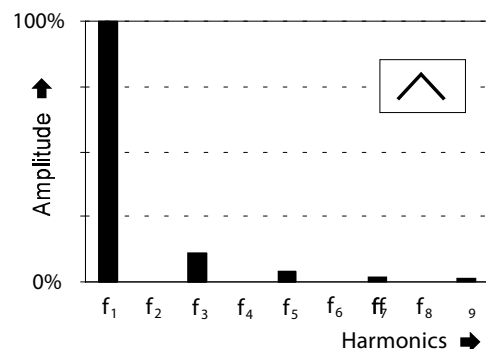

## Modulation

The amount of harmonics of the crude timbral material is crucial for the possibilities in sound shaping with the subsequent voltage-controlled filter (VCF). Subtractive sound synthesis using a VCF (see below) can only attenuate or amplify harmonics that are already there. Therefore, the sine and triangular waves only play a minor role here. When the VCF resonance is set to maximum, it can be used as a sine wave oscillator if one is required for a specific sound.

If a low frequency oscillator is available, it can be used for modulating either the VCO pitch (frequency modulation = FM, also called “vibrato”) or the pulse width (pulse width modulation = PWM). Simple LFOs deliver frequencies in the range of 0.1 Hz to 10 Hz while more sophisticated ones have a significantly wider range (0.01 Hz to 5 kHz) with switchable frequency ranges for better adjustment.

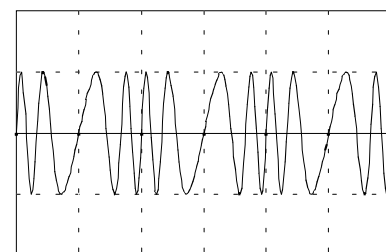

Modulation frequencies within audio range should be dealt with in more detail as they can produce very special results. If a VCO is modulated by a frequency close to its own, a completely new sound will be created. In this case the VCO also produces inharmonic overtones, i.e. tones whose frequencies are not proper multiples of the VCO frequency. This acoustic phenomenon forms the basis of what is known as FM Synthesis which is used on several digital synthesizers. If e.g. a VCO, oscillating at 1 kHz (1,000 Hz), is modulated by a frequency of 400 Hz, so-called “side bands” around the the VCO frequency are created which are grouped symmetrically around the VCO frequency as proper multiples of the modulation frequency. For the example illustrated here, this would result in: 1,000 Hz – 1,400 Hz – 11,800 Hz - 200 Hz, etc...

Strictly speaking this only applies to pure sine wave frequency modulation, i.e. if both, VCO and LFO, are sine wave oscillators. With other waveforms further (in)harmonic overtones will be added. Inharmonic sounds, similar to frequency modulation, are also produced by pulsewidth modulation at high frequencies. In practice, this principle is used for creating extremely inharmonic sounds. The degree of being inharmonic depends on the strength (amplitude) of LFO modulation as well as on the frequency ratio between VCO and LFO. “Experimentation is better than theory” applies here. You should try various settings for LFO frequency and LFO amplitude. Most probably the resulting waveforms are not ideal for sweet, “beautiful” timbres but can be used for more extreme, “vicious” sounds instead. Your neighbors will love you!

## Filters

With subtractive sound synthesis, the further processing of the tonal “crude material” (VCO signal) will be done by a voltage-controlled filter (VCF) first which is usually followed by a voltage-controlled amplifier (VCA).

There are different **types** or characteristics of filters. The basic types are low pass, band pass, and high pass while the types notch and allpass are less common. The filter types differ in how they pass the frequency resp. which frequency ranges are rejected. A low pass passes all frequencies below the cutoff frequency and cuts off all frequencies above. The high pass works just the other way round since it lets all frequencies that are above the cutoff frequency pass and cuts off all frequencies below. A band pass lets all frequencies within a certain range (band) pass and rejects all frequencies outside this range. A notch cuts out a certain frequency range (inverse function of the bandpass). An allpass lets all frequencies pass but it performs a phase-shift depending on the frequency. All these filter types have a different and musically interesting effect on the treated sound. Dark Energy II uses a multimode filter that can continuously crossfade between lowpass, notch, highpass and bandpass.

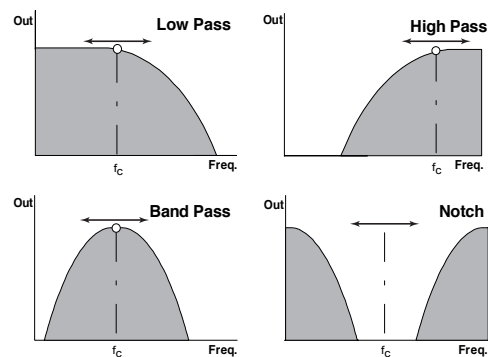

Lowpass, highpass, bandpass and notch

Apart from the type of VCF, another important parameter of a filter is its **slope** which is measured in dB/octave. It describes how steep the transition from passing to rejection is. The “ideal” filter would have an infinite slope, i.e. the transition occurs immediately (e.g. 999 Hz would pass totally while 1,000 Hz would be suppressed completely). In reality, this transition is not abrupt but continuous, depending on the filter’s slope. For musical purposes, a high-quality filter would have a slope of 24 dB/octave or 12 dB/octave. The latter are very useful for special applications (usually for high pass, band pass, and notch). Dark Energy II uses a 12 dB/octave multimode filter which offers lot’s of sonic capabilities.

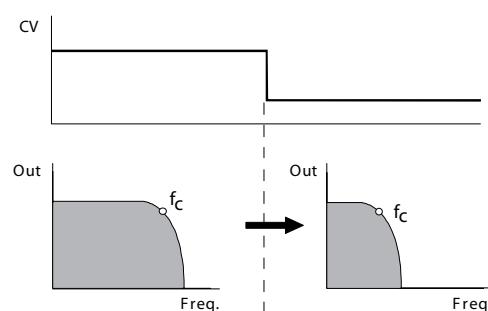

Charakteristics of a lowpass filter

A further filter parameter is **resonance** (or emphasis). If the filter has an adjustable resonance, frequencies around the cutoff point can be emphasized. The filter will become more of a band pass with an underlying low pass. For musical applications it is very important that the filter resonance is adjustable. VCFs without adjustable resonance are rarely used. Overtones around the cutoff point are emphasized the higher the resonance value is. This yields the resonating and “twittering” sounds typical of an analog filter. On many filters the resonance can be set to such a high level that self-oscillation of the filter occurs (even without any input). This allows you to use the filter as a sine wave oscillator

instead of the VCO for special applications.

You guessed it - Dark Energy II's filter is also capable of self-oscillating and thus creating a whole lot of typical synthesizer sounds.

There are several ways to **control the filter's cutoff frequency**.

First, it can be adjusted manually by the "Freq." pot. ADSR as well as LFO 2 can influence the cutoff frequency at varying degrees of intensity, too.

The intensity is set by the XFM control. Additionally, the filter is controllable via MIDI, i.e. its cutoff frequency can be controlled by any MIDI controller and / or by the velocity data of the incoming MIDI notes. Finally, by using a switch, you can determine whether the VCF cutoff frequency follows the VCO frequency (keyboard tracking, keyboard follow). Filter resonance can be adjusted until self-oscillation of the filter occurs. The same applies to the VCO-LFO (LFO 1) with regard to the LFO for the filter (LFO 2). LFO 2 can also produce frequencies up to audio range. The timbral results of VCF frequency modulation by audio frequencies are similar to those of the VCO. You can create metallic sounds typical of FM synthesis, especially at high frequency settings, no matter whether you use tonal material (VCO / external audio signal) or not. You can even create vowel sounds when setting the VCF to the appropriate value, using slowly evolving ADSR envelopes. The sound will become really extreme if you use frequency modulation at audio rate for both VCF and VCO. The tonal results are nearly unpredictable. There is only one way to tell: Go ahead, and watch your eardrums! More often than once the results will be totally surprising.

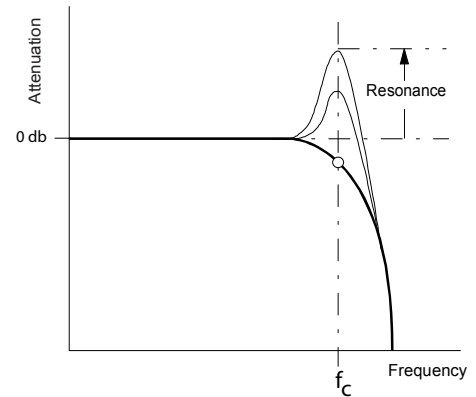

Resonance changes the filter characteristics

## Amplifiers

The voltage-controlled amplifier (VCA) amplifies – would you have guessed – the sound by a factor between 0 and 1, governed by a control voltage, usually from the envelope generator and/or the LFO. The VCA controls the loudness contour of the sound or its articulation, if you want to use a musical term. The text above explained how the components VCO, VCF, and VCA generate or process the audio signal itself.

We have already mentioned components that do not generate any audible signals, but generate control voltages to modulate the parameters of the sound-processing modules with. These are the envelope generator (or ADSR) and the Low Frequency Oscillator (LFO).

## Envelope Generators

Envelope generators, usually of the ADSR species (attack - decay - sustain - release), produce a sequence of four voltages which can be used for controlling VCO frequency, VCF cutoff frequency, and VCA amplitude. The ADSR produces a "one shot" contour in contrast to an LFO which generates a continuous modulation. The envelope is made up of 4 parameters: attack time, decay time, sustain level, and release time.

When depressing a key on a keyboard (note-on command / gate = on), the envelope will rise within a period of time which can be set by the "attack" control. After reaching its maximum, the envelope will decay to the sustain level within a period of time, adjustable by the "decay" control. The envelope will sustain this level until the key is released again (note-off command / gate = off). Then it will return to zero within a period of time adjustable with the "release" control.

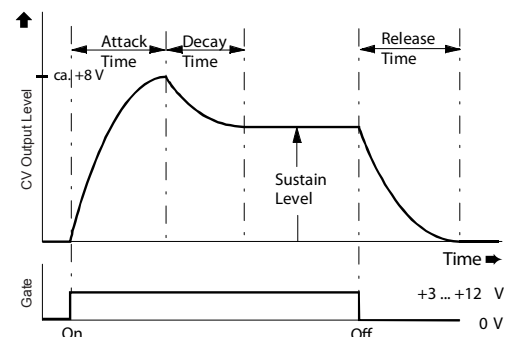

ADSR Envelope and its Parameters

## Low Frequency Oscillators

An LFO is a Low Frequency Oscillator which generates continuous control voltages over a wide range. It can produce several waveforms. Both LFOs of Dark Energy II produce triangular and square waveforms. The latter can be used for “trills” in modulation, while the former creates a continuous “up and down” modulation. The LFOs can be used as modulation sources for all of Dark Energy II’s crucial parameters.

## Interaction

The following figure shows the interaction of all the components mentioned above. It shows the audio signal path (shaded) with oscillator (“crude sound”, “pitch”), filter (“timbre”) and amplifier (“loudness”). In addition to these modules you will see the modulating or controlling elements (envelope generator, LFO) which produce the control voltages necessary to control the parameters of the aforementioned components.

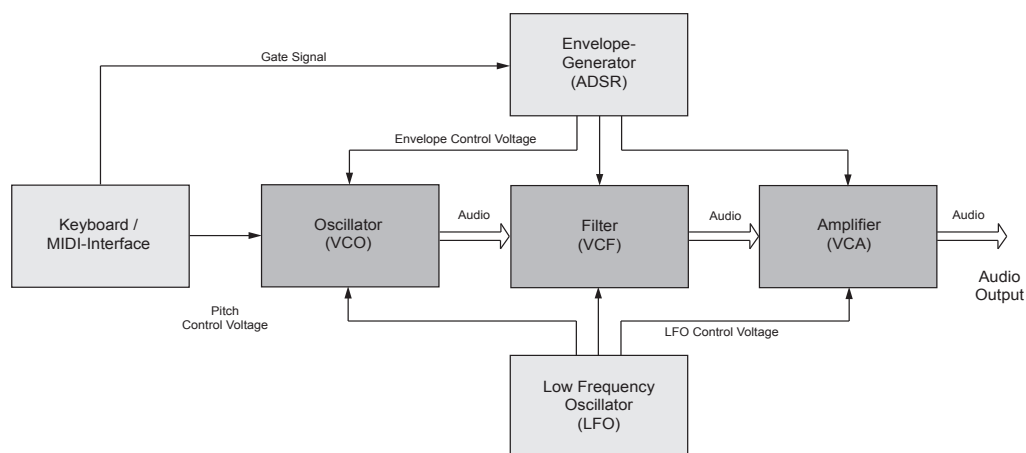

If you feel like going deeper into the secrets of sound synthesis, please check out this book:

Allen Strange, *Electronic Music - Systems, Techniques and Controls*, 2nd edition, Wm. C. Brown Company Publishers, Iowa, ISBN 0-697-03602-2

This is one of the most comprehensive and useful publications about sound synthesis and synthesizers – recommended reading essential for newcomers and advanced musicians alike.

## 6. Addendum

### Service and terms of warranty.

Concerning service and warranty conditions, please refer to our terms of business.  
You will find our terms of business at:

[www.doepfer.de](http://www.doepfer.de)

Doepfer Musikelektronik GmbH  
Geigerstr. 13  
D-82166 Gräfelfing / Deutschland

#### EG Conformity

Für das als Doepfer Musikelektronik GmbH „Dark Energy II“ bezeichnete Produkt wird hiermit bestätigt, dass es den Schutzanforderungen entspricht, die in der Richtlinie 89/336/FWG des Rates zur Angleichung der Rechtsvorschriften der Mitgliedsstaaten über die elektromagnetische Verträglichkeit festgelegt sind. Es entspricht außerdem den Vorschriften des Gesetzes über die elektromagnetische Verträglichkeit von Geräten (EMVG) vom 30. 08. 1995. Zur Beurteilung des Produkts wurden folgende harmonisierende Normen herangezogen:  
EM 50 082-1: 1992, EN 50 081-1 : 1992, EN60065 : 1995  
Please refer to our website „terms of business“.

#### Disposal

This device complies to the EU guidelines and is manufactured RoHS conform without the use of lead, mercury, cadmium and chrome. Still, this device is special waste and disposal in household waste is not permitted.

For disposal, please contact your dealer or :

Doepfer Musikelektronik GmbH, Geigerstr. 13, D-82166 Gräfelfing / Deutschland

#### IMPRINT

Owners Manual by Matthias Fuchs / VISOPHON and Stephen Parsick;  
Dieter Doepfer, Christian Asall / Doepfer Musikelektronik GmbH ©

Copying, distribution or any commercial use in any way is prohibited and needs the written permission by the manufacturer.

Specifications subject to change without notice.

Although the content of this owners manual has been thoroughly checked for errors, Doepfer Musikelektronik GmbH cannot guarantee that it is error-free throughout. Doepfer Musikelektronik GmbH cannot be held liable for any misleading or incorrect information within this guide.

# DOEPFER

Doepfer Musikelektronik GmbH  
Geigerstr. 13  
D-82166 Gräfelfing / Deutschland

[www.doepfer.de](http://www.doepfer.de)

**DARK ENERGY II**

*DOEPFER MUSIKELEKTRONIK GMBH*