

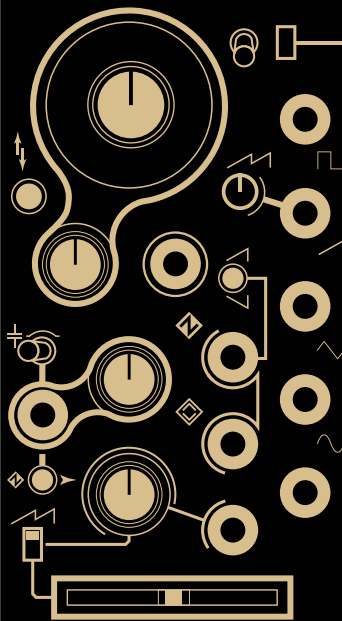

SPECIALIST
SYNTHESIZERS



neóni

Through-Zero Oscillator
User Manual

Contents

3

Description / Features

4

Installation / Specifications

5

Overview

6

Waveforms

8

Frequency Modulation
& Waveshaping

10

Oscillator Synchronization

12

Control Voltage

14

Frequency/Pitch

15

Patch Examples

- East Coast Synth Voice
- Traditional FM
- Through-Zero FM
- Sawtooth Polarity Switch
- Through-Zero Oragami
- Feedback Seagulls
- Chug-Chug

Description

FM with tonality! At its core, the Instruō **neóni** is a traditional analogue oscillator. What sets it apart from other oscillators in the Instruō product line is it's Through-Zero FM functionality with AC and DC coupled operation. Add that to its precision soft sync and directional hard sync modes, nonlinear wavfolding, internal modulation routings, and you end up with the most tonal FM sounds imaginable.

Unlike traditional FM, where an oscillator momentarily stalls as negative voltage pulls its frequency down to 0 Hz, **neóni** inverts the polarity of its waveforms until positive voltage pulls it back through 0 Hz. This behavior allows for complex waveforms with less non-harmonic sidebands. Less clang, more bang!

Drop it all to subsonic territory for organic modulations of morphable voltage.

Features

- Linear through-zero & traditional FM with AC & DC coupled functionality
- Internal modulation routing and general-purpose CV input with attenuator
- Split sawtooth morphing and nonlinear wavfolding
- Precision soft sync
- Directional hard sync
- Individual waveform outputs
- LFO mode

Installation

1. Confirm that the Eurorack synthesizer system is powered off.
2. Locate 12 HP of space in your Eurorack synthesizer case.
3. Connect the 10 pin side of the IDC power cable to the 2x5 pin header on the back of the module, confirming that the red stripe on the power cable is connected to -12V.
4. Connect the 16 pin side of the IDC power cable to the 2x8 pin header on your Eurorack power supply, confirming that the red stripe on the power cable is connected to -12V.
5. Mount the Instruō **neóni** in your Eurorack synthesizer case.
6. Power your Eurorack synthesizer system on.

Note:

This module has reverse polarity protection.

Inverted installation of the power cable will not damage the module.

Specifications

- Width: 14 HP
- Depth: 27mm
- +12V: 90mA
- -12V: 90mA

neóni | *ni:əni* | **verb** (engineering) to adjust an instrument to zero, a point on a scale or instrument from which a positive or negative quantity is reckoned



Key —

- | | | |
|--------------------|-----------------------------|---------------------------|
| 1. Square Output | 9. FM Attenuator | 17. CV Destination Switch |
| 2. Sawtooth Output | 10. AC/DC Coupled Toggle | 18. CV Input |
| 3. Split Sawtooth | 11. Traditional/T.Z Switch | 19. CV Attenuator |
| 4. Triangle Output | 12. Hard Sync Input | 20. Coarse |
| 5. Sine Output | 13. Hard Sync Direction | 21. Fine |
| 6. Wavefold Output | 14. Soft Sync Input | 22. 1V/Oct Input |
| 7. Wavefold | 15. Charge Direction Button | 23. LFO Toggle |
| 8. FM Input | 16. Signal Router Toggle | |

Waveforms

 **Square Output:** Square waveform output.

 **Sawtooth Output:** Sawtooth waveform output.

Split Sawtooth: Controls the waveshaping applied to the **Sawtooth Output** by offsetting from the split at the centre of the wavelength

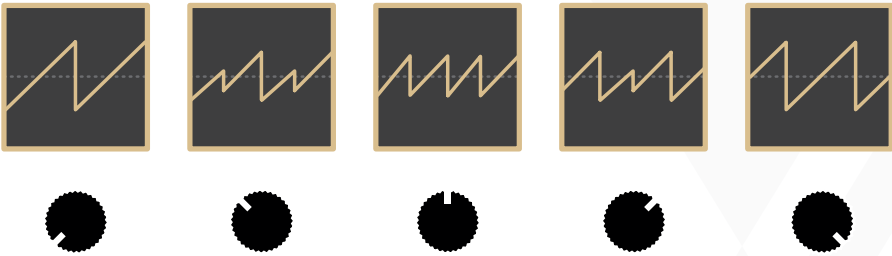

- When the knob is fully anticlockwise, the sawtooth waveform is at its default phase, frequency, and amplitude.
- Turning the knob towards the centre morphs to a sawtooth waveform at half the amplitude and double the frequency of the original sawtooth waveform.
- Turning the knob fully clockwise morphs to the original sawtooth waveshape but the ramp now starts at a 180 degree offset from the original sawtooth waveform.

 **Triangle Output:** Triangle waveform output.

 **Sine Output:** Sine waveform output.

Wavefold Output: Wavefolded waveform output.

- This circuit uses nonlinear wavefolding on **neóni's** triangle core and folds between at 10Vpp range, but can expand to $\approx 14Vpp$ at its outer range.
- The waveform is determined by the **Wavefold** fader and (sometimes) the **CV Input** (See **Control Voltage** for more information).

Wavefold: Controls the amount of wavefolding applied to the core triangle waveform.

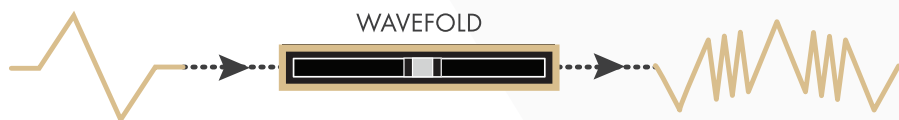

Frequency Modulation & Waveshaping

FM Input: A bipolar control voltage input for the frequency parameter.

- Control voltage is scaled by the **FM Attenuator** and summed with the values set by the **Coarse** and **Fine** knobs.
- The **FM Input** is linear.
- The polarity of the incoming signal routed to the **CV Input** (before the signal reaches the **FM Attenuator**) defines the inversion of the sawtooth waveform.

FM Attenuator: Determines the depth of frequency modulation applied to the fundamental frequency.

- Turning the knob anticlockwise will decrease the depth of frequency modulation.
- Turning the knob clockwise will increase the depth of frequency modulation.

AC/DC Coupled Toggle: Toggles the **FM Input** between AC coupled and DC coupled operation.

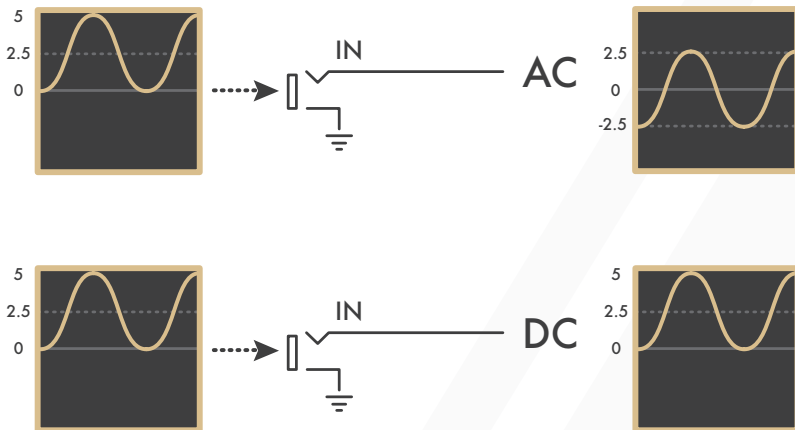

- If set to AC coupled operation, frequency modulation can be more tonal in **T.Z.** configuration. Any DC offset within the signal connected to the **FM Input** is filtered out.
- If set to DC coupled operation, frequency modulation can be more clangorous in **T.Z.** configuration. Any DC offset within the signal connected to the **FM Input** is present and will offset the fundamental frequency.

Trad/T.Z. Switch: Switches between traditional FM and through-zero FM operation.

- When set to traditional FM operation, **neóni** behaves similarly to most analog oscillators with linear FM functionality. Pitch-tracking **neóni** as the carrier within an FM operator changes the pitch of the sound, whereas pitch-tracking the modulator changes the timbre of the sound.
- When set to through-zero FM, more tonal FM functionality is available. Pitch-tracking the modulator within an FM operator changes the pitch of the sound, whereas pitch-tracking the **neóni** as the carrier changes the timbre of the sound.
- If the **Trad/T.Z. Switch** is in the down position and the **AC/DC Coupled Toggle** is in the right position, turning the **FM Attenuator** will set the oscillator to higher frequencies when no signal is present at the **FM Input**.

Oscillator Synchronization

Hard Sync Input: All waveform cycles reset on a hard rising-edge signal.

Hard Sync Direction: Controls the behavior of the **Hard Sync Input**.

When triggered, the core triangle charge will immediately reset to 0V.

Low Frequency

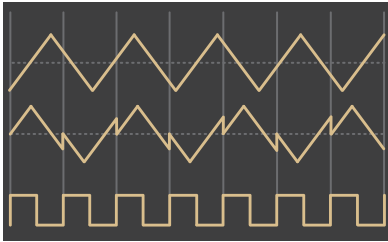

Audio Rate

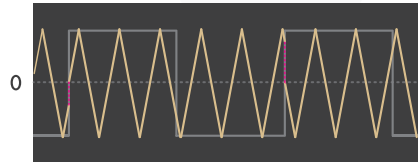

If the toggle is in the centre position, the new cycle's polarity is dictated by the charge direction at the time of sync. A sync signal received during the triangle's ascending ramp will reset to a new positive charge from 0V. A sync signal received during the triangle's descending ramp will reset to a new negative charge from 0V.

Low Frequency

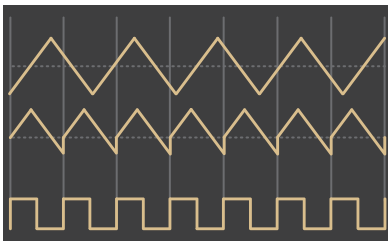

Audio Rate

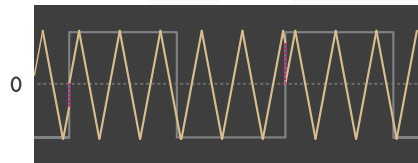

If the toggle is in the up position the core triangle charge will always reset to a positive charge from 0V, regardless of the ramp direction at the time of synchronisation.

Low Frequency

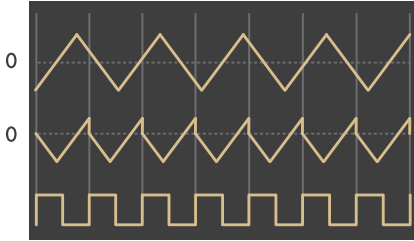

Audio Rate

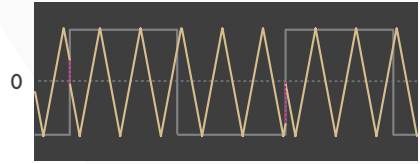

If the toggle is in the down position the core triangle charge will always reset to a negative charge from 0V regardless of the ramp direction at the time of synchronisation.

Soft Sync Input: neóni's core triangle changes its charge direction on a hard rising edge signal.

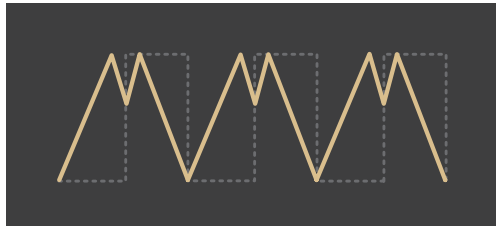

Charge Direction Button: Controls a manual soft synchronization of the core triangle waveform's charge direction.

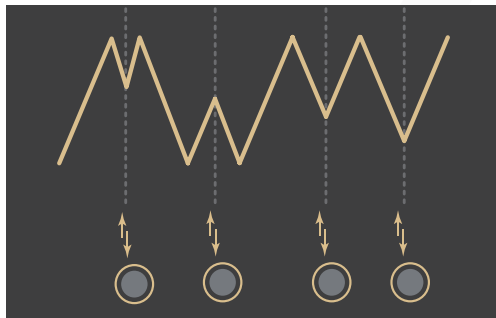

Control Voltage

Signal Router Toggle: Routes the signal present at the **FM Input** to different parts of the circuit. Incoming signals will always modulate the frequency of **neóni** (when unattenuated), regardless of the toggle position.

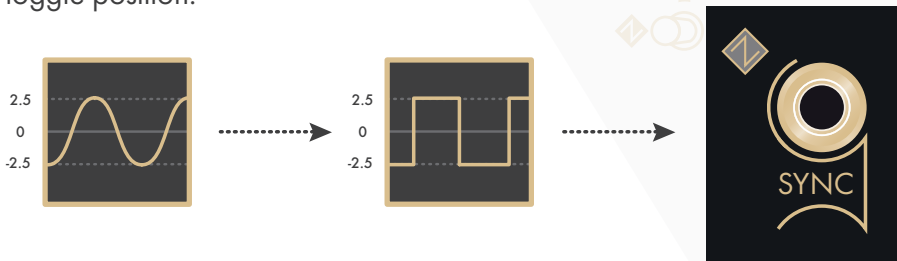

- If the toggle is in the left position, the positive portion of the incoming signal is clipped and then routed to the **Hard Sync Input**. This can help stabilize the organic nature of through-zero FM.
- If the toggle is in the centre position, additional routing is disabled.

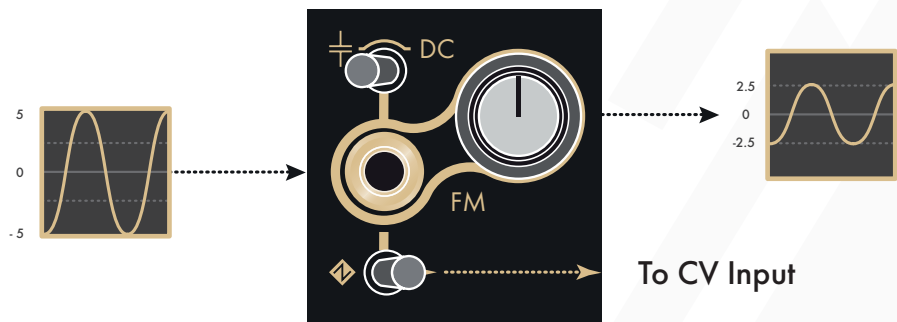

- If the toggle is in the right position, the incoming signal will be routed to the **CV Input** before the signal reaches the **FM Attenuator**. This allows the incoming signal to be connected to the **FM Input** to be scaled by the **FM Attenuator** (for frequency modulation) and the **CV Attenuator** (for general-purpose modulation). The additional parameter controlled is selected by the **CV Destination Switch**. Connecting a signal to the **CV Input** will break the normalised routing from the **FM Input**.

CV Destination Switch: Sets the modulation destination for the **CV Input** to either wavefold amount or split sawtooth waveshaping.

CV Input: The **CV Input** is a bipolar control voltage input that can control either the wavefold amount or the split sawtooth waveshaping based on the position of the **CV Destination Switch**.

- Control voltage is scaled by the **CV Attenuator** and summed with the value set by either the **Wavefold** fader or the **Split Sawtooth** knob.
- If the **CV Destination Switch** is in its down position (making wavefold amount the target parameter) and the **Wavefold** fader is set anywhere below 90%, negative CV will mute the **Wavefold Output**.
- Control voltage can push either parameter past their maximum manual control range.

CV Attenuator: Determines the depth of modulation applied to the currently selected CV destination.

- Turning the knob anticlockwise will decrease the depth of modulation.
- Turning the knob clockwise will increase the depth of modulation.

Frequency/Pitch —

Coarse: The **Coarse** knob controls the fundamental frequency of the oscillator. It determines the pitch of all waveforms.

- Turning the knob anticlockwise will decrease the frequency.
- Turning the knob clockwise will increase the frequency.

Fine: The **Fine** knob is used for minute control of the oscillator's fundamental frequency and is relative to the frequency value set by the **Coarse** knob. It also determines the pitch of all waveforms.

- Turning the knob anticlockwise will decrease the frequency.
- Turning the knob clockwise will increase the frequency.

1V/Oct Input: The **1V/Oct Input** is a bipolar control voltage input that is calibrated to 1 volt per Octave.

- This is traditionally used for frequency control (musical pitch) sent from a sequencer or keyboard.
- Control voltage is summed with the values set by the **Coarse** and **Fine** knobs.

LFO Toggle: The **LFO Toggle** enters **LFO Mode** turning **neóni** into a fully-functional low frequency oscillator. **LFO Mode** forces all waveform outputs to oscillate within subsonic frequency ranges.

Patch Examples

East Coast Synth Voice:

Summary: The sequencer or keyboard sends voltages to **neóni** while simultaneously triggering the envelope generator. The CV output of the envelope generator opens a filter and VCA, allowing **neóni** to pass through. More traditional East Coast patches would incorporate separate envelope generators for the filter and VCA.

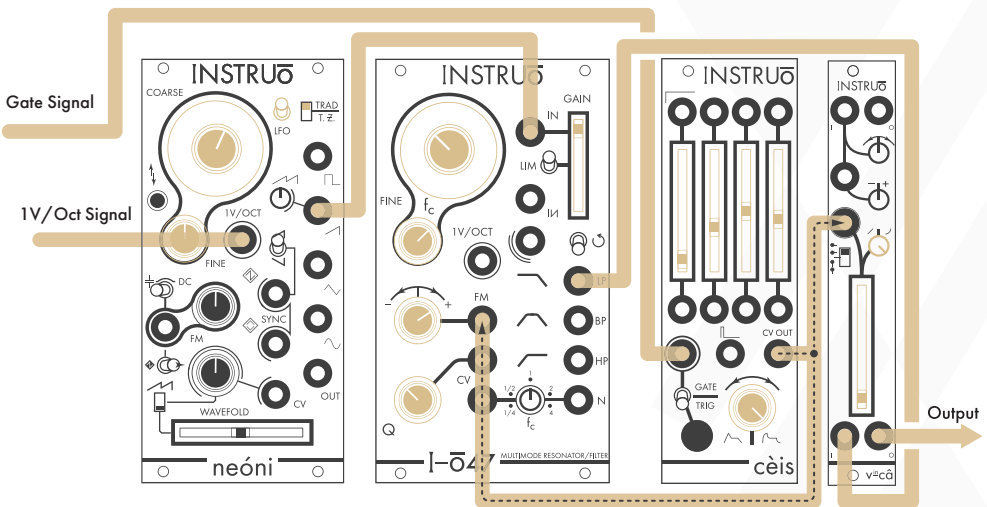

Audio Path:

- Set the **LFO Toggle** of **neóni** to its up position, so that it oscillates at audio rate.
- Set the **Trad/T.Z. Switch** of **neóni** to its up position, so that traditional FM operation is selected.
- Connect the **Sawtooth Output** of **neóni** to the audio input of a filter.
- Connect the audio output of the filter to the audio input of a VCA.
- Monitor the audio output of the VCA.
- Set the fundamental frequency of **neóni** to a desired position using the **Coarse** and **Fine** knobs.

- Set the cutoff frequency of the filter to a desired position.
- Set the resonance of the filter to a desired position.
- Set the gain of the VCA to its minimum position if applicable.

Control Path:

- Connect the 1V/Oct output of a sequencer or keyboard to the **1V/Oct Input** of **neóni**.
- Connect the gate output of the sequencer or keyboard to the trigger input of an envelope generator.
- Connect the CV output of the envelope generator to a multiple.
- Connect one copy of the envelope generator CV signal to the CV input of the filter and set the corresponding CV attenuator to a desired position.
- Connect a second copy of the envelope generator CV signal to the CV input of the VCA and set the corresponding CV attenuator to a desired position.
- Set the envelope stages to desired positions.

Traditional FM:

Summary: A secondary oscillator modulates the frequency of **neóni**. In this setup, **neóni** is the carrier and the secondary oscillator is the modulator. Sequencing or keytracking **neóni** will change the pitch of the sound. Experiment with different carrier:modulator ratios by changing the frequencies of both oscillators. Experiment with the **AC/DC Coupled Toggle** to hear the differences in tone.

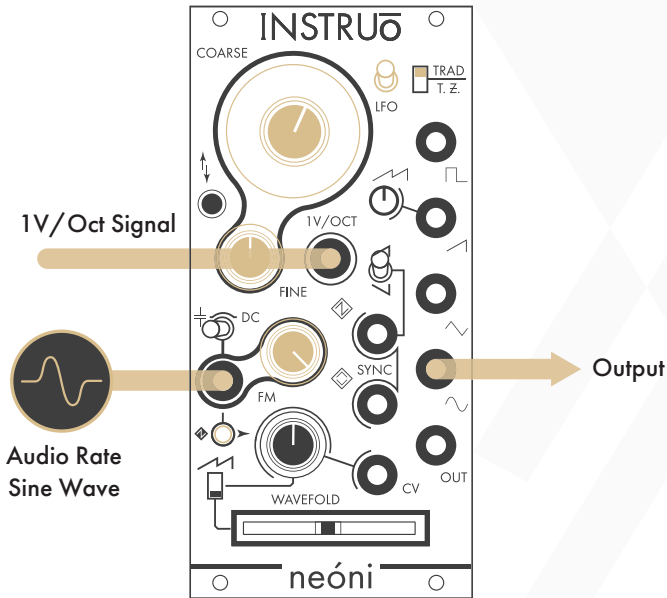

Audio Path:

- Monitor the **Sine Output** of **neóni**.
- Set the **LFO Toggle** of **neóni** in the up position, so that it oscillates at audio rate.
- Set the **Trad/T.Z. Switch** of **neóni** to its up position, so that traditional FM operation is selected.
- Tune the **Coarse** knob and the **Fine** knob of **neóni** to desired positions.

Control Path:

- Set the **Signal Router Toggle** to its centre position, so that internal signal routing is disabled.
- Connect an audio rate sine waveform to the **FM Input** of **neóni** and set the **FM Attenuator** fully clockwise.

Through-Zero FM:

Summary: A secondary oscillator modulates the frequency of **neóni**. In this setup, **neóni** is the carrier and the secondary oscillator is the modulator. Sequencing or key-tracking the modulator will change the pitch of the sound. Experiment with different carrier:modulator ratios by changing the frequencies of both oscillators. Experiment with the **AC/DC Coupled Toggle** to hear the differences in tone.

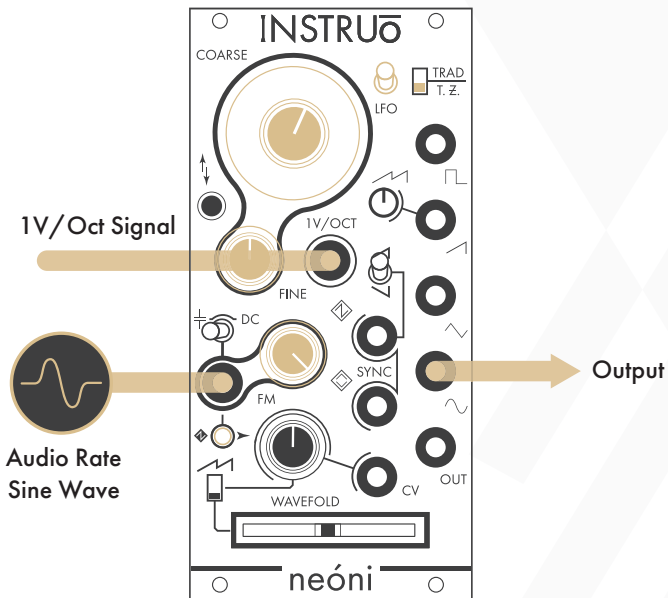

Audio Path:

- Monitor the **Sine Output** of **neóni**.
- Set the **LFO Toggle** of **neóni** in the up position, so that it oscillates at audio rate.
- Set the **Trad/T.Z. Switch** of **neóni** to its down position, so that through-zero FM operation is selected.
- Tune the **Coarse** knob and the **Fine** knob of **neóni** to desired positions.

Control Path:

- Set the **Signal Router Toggle** to its centre position, so that internal signal routing is disabled.
- Connect an audio rate sine waveform to the **FM Input** of **neóni** and set the **FM Attenuator** fully clockwise.

Sawtooth Polarity Switch:

Summary: If the sawtooth waveform is used, connecting negative CV to the **FM Input** will change the polarity of the sawtooth waveform, regardless of the **FM Attenuator's** knob position. A threshold comparator selects the polarity of the sawtooth wave. The polarity can be switched at audio rate for hard sync-style effects.

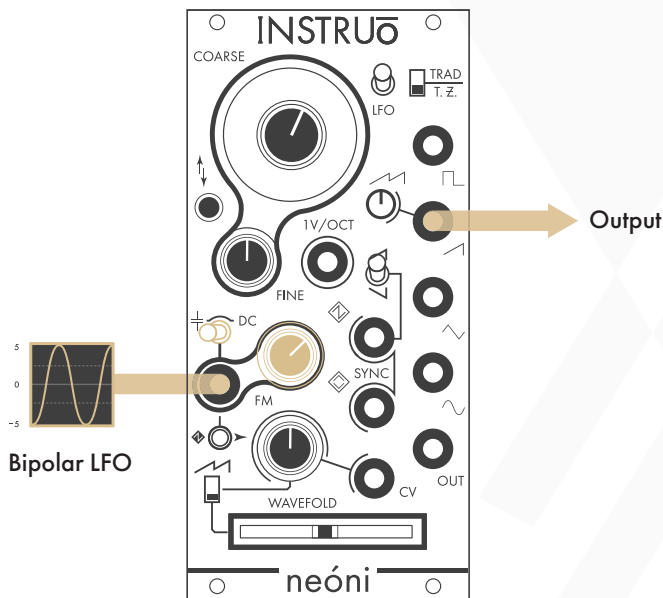

Audio Path:

- Monitor the sawtooth waveform via an oscilloscope and an audio output.

Control Path:

- Set the **AC/DC Coupled Toggle** to a desired position. The AC setting will have smoother polarity switching than the DC setting.
- Connect a bipolar LFO or a bipolar audio signal to the **FM Input**.
- Set the **FM Attenuator** to a desired position, this will change the timbre of the polarity-switched sawtooth waveform.

Through-Zero Oragami:

Summary: The modulator within the FM operator is connected to both the FM Input and the wavefold parameter. Timbre is determined by the pitch and wavefold parameters as well as the FM Attenuator and CV Attenuator.

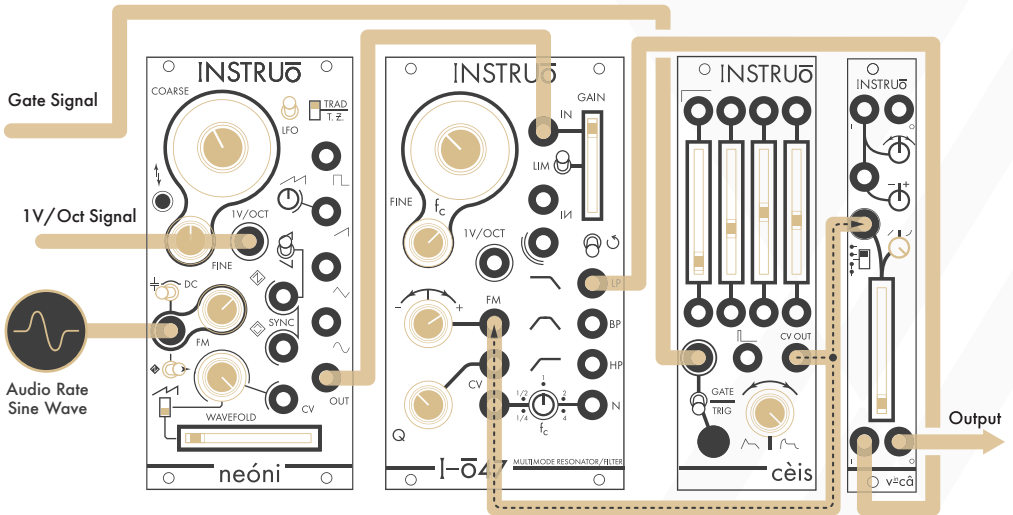

Audio Path:

- Create an **East Coast Synth Voice** patch using the **Wavefold Output** of **neóni**.
- Set the **Wavefold** fader of **neóni** to its minimum position.
- Tune the **Coarse** knob and the **Fine** knob of **neóni** to 11:00 and 12:00, respectively.

Control Path:

- Set the **AC/DC Coupled Toggle** to its left position, so that AC coupled FM operation is selected.
- Set the **Signal Router Toggle** to its right position, so that internal signal routing from the **FM Input** is enabled for the **CV Input**.

- Set the **CV Destination Switch** to its down position, so that incoming signal at the **FM Input** will modulate the wavefold amount.
- Connect an audio rate sine waveform of a secondary oscillator to the **FM Input** and set the **FM Attenuator** to around 2:00.
- Set the **CV Attenuator** to its fully clockwise position.

Feedback Seagulls:

Summary: The **Sine Output** feeds back into the wavefolder amount parameter and the **Wavefold Output** feeds back into the **FM Input**. Moving the **Coarse** knob and the **Wavefold** fader will affect the “bird activity.”

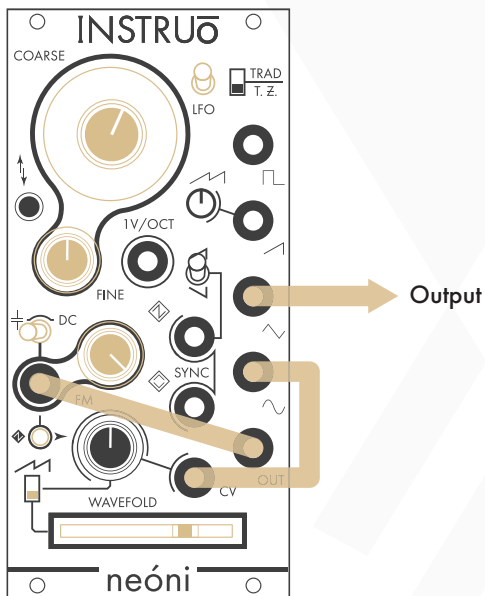

Audio Path:

- Set the **LFO Toggle** to its up position, so that **neóni** oscillates at audio rate.
- Set the **Trad/T.Z. Switch** of **neóni** to its up position, so that traditional FM operation is selected.
- Set the **Coarse** knob to between 1:00 and 2:00.
- Set the **Fine** knob to its centre position.
- Monitor the **Triangle Output**.

Control Path:

- Set the **AC/DC Coupled Toggle** to its left position, so that AC coupled FM operation is selected.
- Set the **CV Destination Switch** to its down position, so that incoming signal at the **CV Input** will modulate the wavefold amount.
- Set the **Signal Router Toggle** to its centre position, so that no additional routing is applied.
- Connect the **Sine Output** to the **CV Input**.
- Set the **Wavefold** fader around 75%.
- Connect the **Wavefold Output** to the **FM Input**.
- Set the **FM Attenuator** to its fully clockwise position.

Chug-Chug:

Summary: The sawtooth and wavefolded waveforms of **neóni** are mixed in **lion**. The output of **lion** as well as a stepped triangle waveform from **Cš-L** are further mixed via the input and inverting input of **I-ō47**. The low pass output of **I-ō47** is sent through the bottom channel of **vincâ**. The output of **vincâ** is sent through **tanh[3]**. A sub square waveform from **Cš-L** is through-zero frequency modulating and hard synchronizing **neóni**. A sequencer or keyboard modulates the pitch of **neóni** and **Cš-L**. The sequencer or keyboard also triggers **cèis**. **cèis** modulates the cutoff frequency of **I-ō47** and the level of **vincâ**. Because **Cš-L** through-zero frequency modulates and hard synchronizes **neóni**, changing the frequency of **Cš-L** will change the pitch of the sound and changing the frequency of **neóni** will change the timbre.

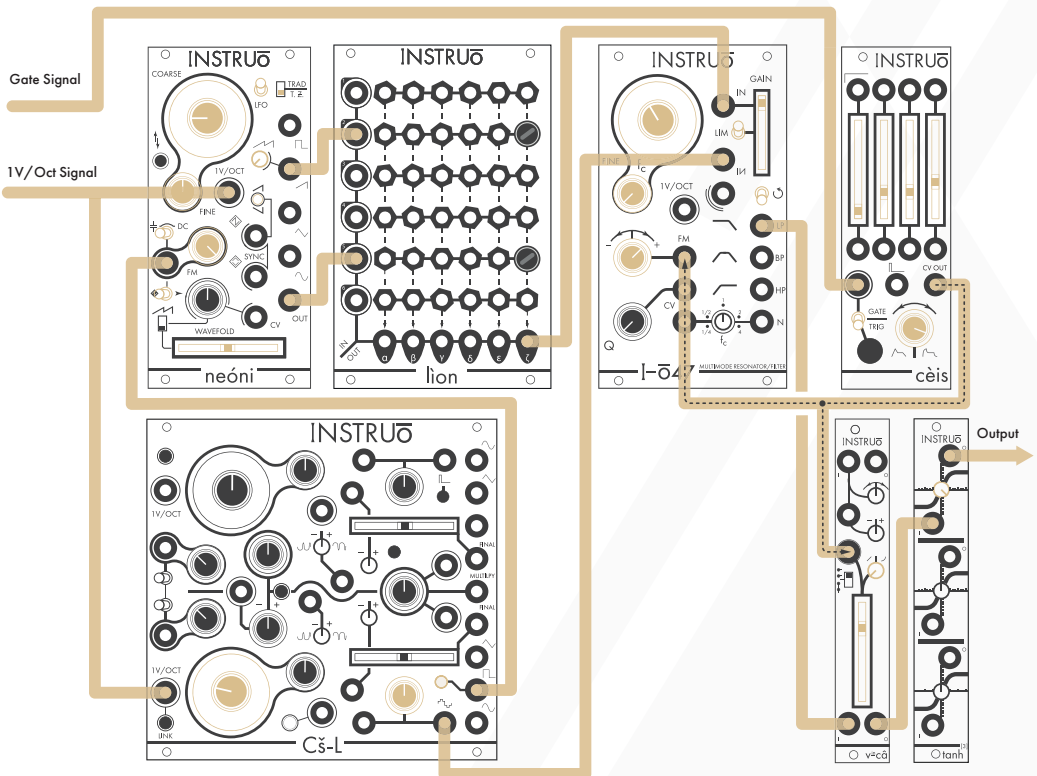

Audio Path:

- Set the **LFO Toggle** of **neóni** to its up position, so that it oscillates at audio rate.
- Set the **Trad/T.Z. Switch** of **neóni** to its down position, so that through-zero FM operation is selected.
- Set the **Hard Sync Toggle** of **neóni** to its centre position, so that hard synchronization happens on every up and down charge direction.
- Set the **Split Sawtooth** knob of **neóni** to its fully anticlockwise position, so that the sawtooth waveform is at its default setting.
- Set the **Wavefold** fader of **neóni** to its centre position.
- Tune the **Coarse** knob and the **Fine** knob of **neóni** to 9:00 and 12:00, respectively.
- Connect the **Sawtooth Output** and the **Wavefold Output** of **neóni** to two inputs of **lion** and connect the corresponding pin cables to mix them to a single output.
- Connect the output of **lion** to the input of **I-ō47** and connect the stepped triangle output of **Cš-L** to the inverting input of **I-ō47**.
- Tune **Cš-L** to around 98 Hz (G2) or a note within this octave.
- Set the stepped triangle's PWM knob to its centre position.
- Set the gain fader of **I-ō47** to its maximum level.
- Set the limiter toggle of **I-ō47** to its up position
- Set the coarse cutoff frequency knob and the fine frequency knob of **I-ō47** to 11:00 and fully anticlockwise, respectively.
- Set the resonance knob of **I-ō47** to 9:00.
- Set the feedback toggle of **I-ō47** to its down position to disable self-oscillation of the resonance.
- Connect the low pass output of **I-ō47** to **vincâ**.
- Set **vincâ** to fully linear
- Set **vincâ**'s amplitude/CV attenuator to around 75%.
- Connect the output **vincâ** to **tanh[3]**.
- Set the level knob of **tanh[3]** to its maximum position.

Control Path:

- Set the **AC/DC Coupled Toggle** to its left position, so that AC coupled FM operation is selected.
- Set the **Signal Router Toggle** to its left position, so that the incoming signal at the **FM Input** is clipped and routed to the **Hard Sync Input**.
- Press the sub button of Cš-L so that it illuminates white and the square wave is one octave below the stepped triangle waveform.
- Connect the sub square output of Cš-L to the **FM Input** of **neóni** and set the **FM Attenuator** fully clockwise. The sub square waveform is now through-zero frequency modulating and hard synchronizing **neóni**.
- Connect the 1V/Oct output of a keyboard or sequencer to the **1V/Oct Inputs** of **neóni** and Cš-L.
- Connect the gate output of the sequencer or keyboard to the trigger input of **cèis**.
- Connect the CV output of **cèis** to a multiple.
- Connect one copy of **cèis**'s CV signal to the CV input of I-ō47 and set the corresponding CV attenuator to 2:00.
- Connect a second copy of **cèis**'s CV signal to the bottom channel CV input of **vincâ**.
- Set the gate/trig toggle of **cèis** to its down position.
- Set the shape knob of **cèis** to 3:30.
- Set the individual stages of **cèis** (attack to its minimum position, decay to 20%, sustain to 20%, and release to 30%).

Manual Author: Collin Russell

Manual Design: Dominic D'Sylva



This device meets the requirements of the following standards: EN55032, EN55103-2, EN61000-3-2, EN61000-3-3, EN62311.