

COLLIDE 4 QUADRATURE SPECTRAL COMPUTER

USER MANUAL

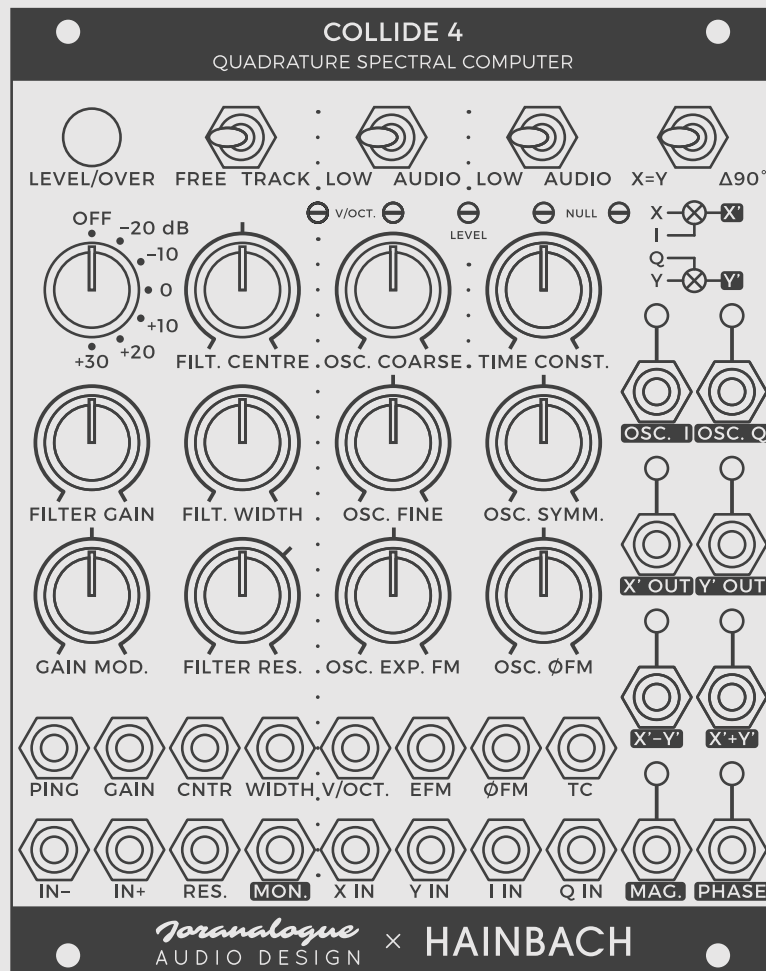

TABLE OF CONTENTS

Foreword by Hainbach	2
Introduction	3
Contents	3
Installation	4
Signal flow	5
Controls & connections	6
A Input section	7
B Oscillator	10
C Detector	12
D Output section	14
E Calibration	15
Patch ideas	18
How lock-in amplifiers work	20
Specifications	24
Support	24
Acknowledgements	25

FOREWORD BY HAINBACH

Thank you for purchasing Collide 4! You are now one step closer to scouring defunct particle accelerators and abandoned research facilities to assemble a massive wall of test equipment in your bedroom studio. Lucky for you, you don't need to go the lengths that I did when I discovered the joy of using nuclear instrumentation for music. All that sonic power is in the palm of your hand now.

When Joran asked me to collaborate on Collide 4, the thing that made me go 'yeah' at once was his stated goal of making this a tool that could be used for science, too. There would be no 'dumbing down' of the original instrument, but rather a transformation to make it work in Eurorack, and music, without hassle. If you read further in the manual, your head might start to spin with all complexity available. If that happens, run a trigger into the ping input and let the walls shake with BASS.

But what is a lock-in amplifier? To put it simply: it locks onto a frequency in a wash of noise, filters it out, matches phase and amplifies it. It's made to sniff out tiny voltage fluctuations in a particle accelerator and other nuclear research applications. What makes it musically interesting is how closely it is related to synthesisers: the original 1960s lock-ins used circuitry and op-amps that are near identical to the most legendary ARP 2500 synthesiser. So, when I first heard one being pinged, I was awed by the rich musicality of it. It can shake a club like little else, or ring clear as a bell in an Arvo Part piece.

All the synthesiser parts of a lock-in are designed for analysis, but with Collide 4 you have them under CV and can patch them in new and exciting ways. It moves way beyond what was ever possible with any lock-in amp: it is a full synth voice and an absolutely smashing audio processor.

I hope you enjoy this module. It's definitely on the Dark Souls side of synthesis, but as challenging as it is, it is very rewarding. It should also make a nice addition to your home nuclear research lab.

Love,

Hainbach, Berlin 2024

INTRODUCTION

The origins of electronic music are found within the early works of a small group of forward-thinking mid-century composers, harnessing electronic test gear to create strange new sounds. Building upon this heritage, today everything comes full circle again through Collide 4.

The first hardware release to be co-developed by acclaimed musician and YouTube sensation Hainbach, Collide 4 builds upon the lock-in amplifier concept, and brings it into the Eurorack world. These atomic age physics research instruments are known for their raw power when used in musical applications. Now, any synthesist can experience this for themselves, at a fraction of the size and weight of a vintage unit, and with full voltage control.

The result is a wholly new kind of analogue synth voice and audio processor, with capabilities far beyond what the avant-garde pioneers could have imagined. Collide 4 is an expression of Hainbach's extensive experience in exploring the deepest musical realms contained within vintage test equipment, and the Joranalogue philosophy of electronic instrument design.

Honouring its innovative dual-phase architecture, this new kind of musical generator and processor has been christened the 'quadrature spectral computer'. The sound? Quite simply: it's smashing!

CONTENTS

In the Collide 4 box, you'll find:

- Product card, stating serial number and production batch.
- 16-to-10-pin Eurorack power cable.
- Mounting hardware: four black M3 x 6 mm hex screws, four black nylon washers and a hex key.
- The Collide 4 module itself, in a protective, reusable cotton bag.

If any of these items are missing, please contact your dealer or support@joranalogue.com.

INSTALLATION

Before installation, make sure your Euro-rack system has been powered down for at least 10 minutes and is placed horizontally on a stable surface.

Locate a free spot in your system in which to mount your module. First plug the included power cable between the module and a free output header on the power distribution board or cable.

Keep an eye on the polarity: the red stripe on the cable, denoting the -12 V power voltage, should always point towards the bottom of the module: 'red stripe down'. All our modules are equipped with keyed headers, which makes it impossible to plug them in the wrong way around.

Also pay attention to the polarity of the cable on the power distribution side. Contact the manufacturer of your rack in case you are uncertain.

Even if the polarity ends up reversed, this will not damage your module. However, this may not be true for modules of other brands.

Next, it's time to screw your module in place. Included with your module, you'll find a set of M3 screws and nylon washers.

Place the nylon washers onto the screw threads, and using the supplied 2.5 mm hex key, fasten the screw/washer combo onto the rack rails, through the module's front panel. If your case uses sliding nuts, you'll need to position them first. Repeat until all screws are in place; always use all the supplied screws to install a module.

Note that some racks might use a different thread than the supplied M3 screws, or the rails might be recessed too deep for the supplied screws to fit. In this case, you'll need to source third-party screws matching your rack.

Now you can power up your rack and enjoy your new module!

SIGNAL FLOW

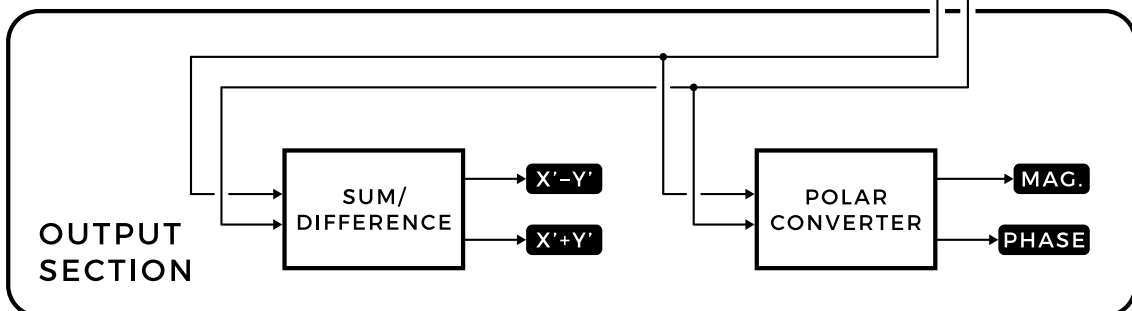
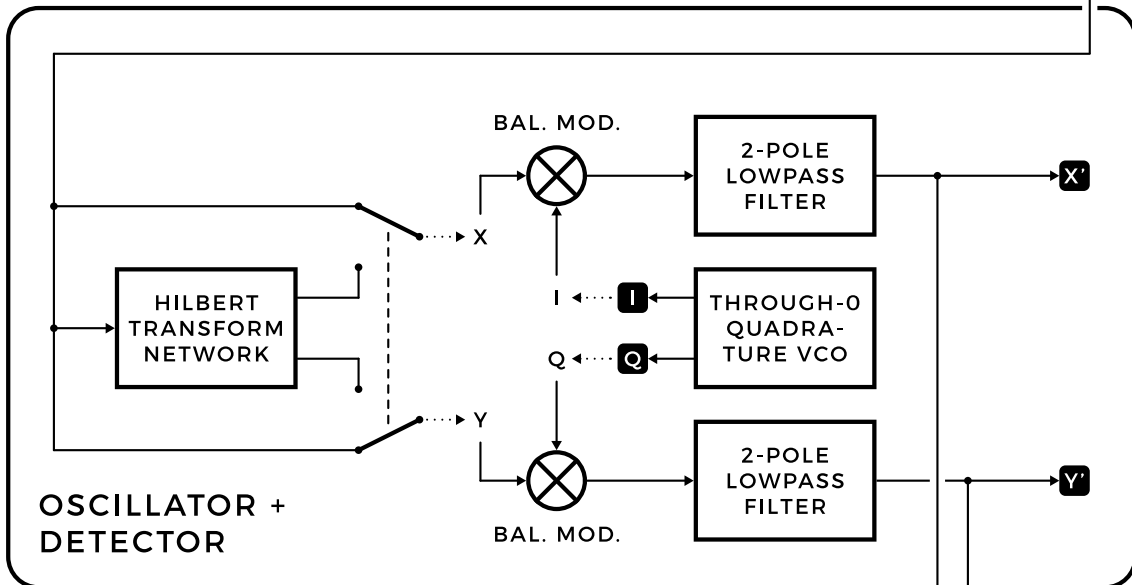
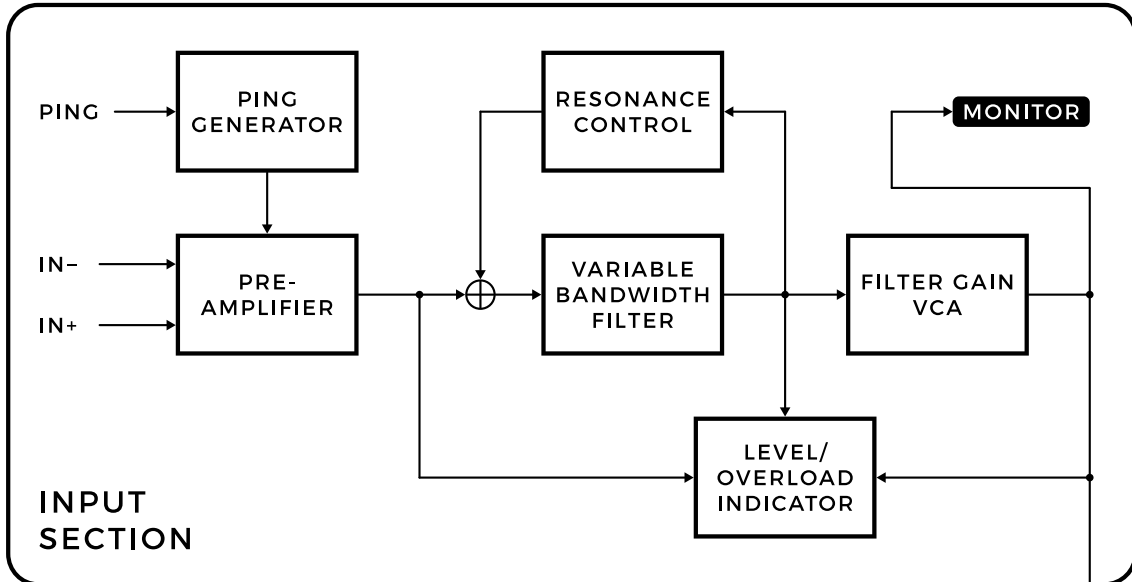

| INPUT  OUTPUT → CONNECTION ...→ NORMALISED CONNECTION ⊕ MIXER

CONTROLS & CONNECTIONS

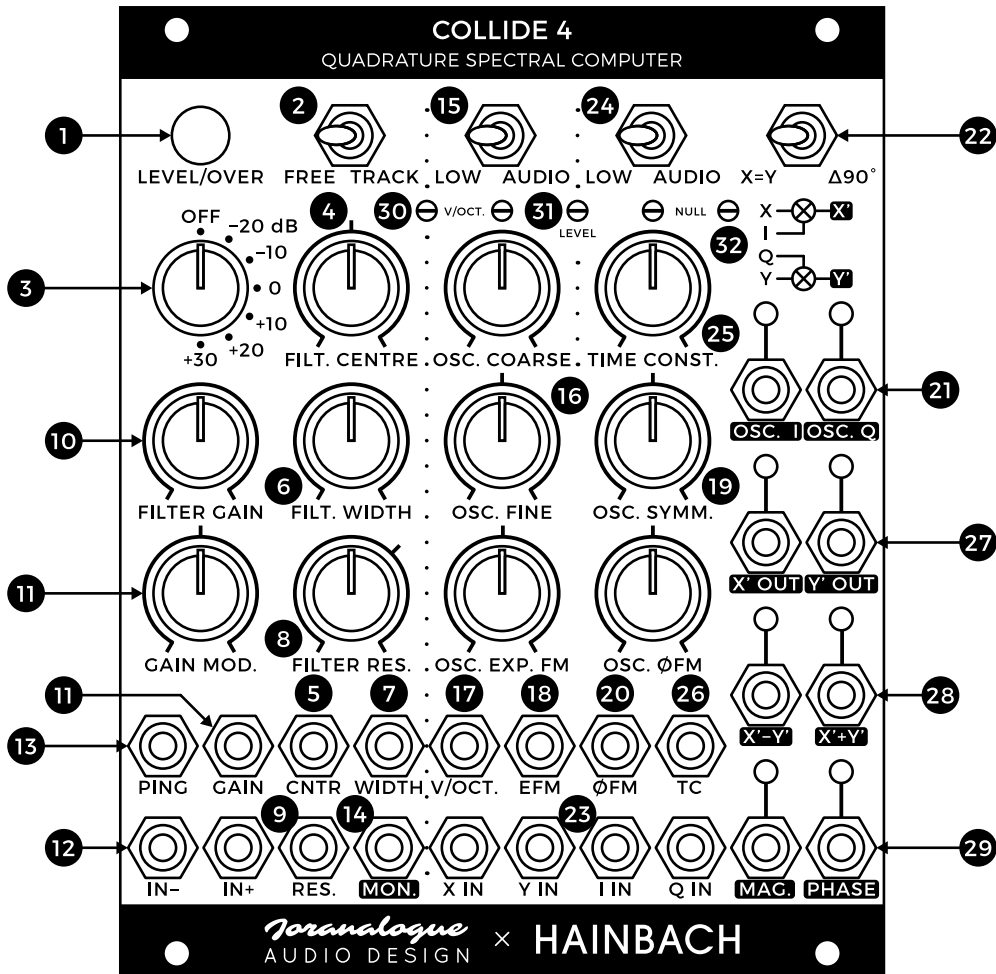

A INPUT SECTION

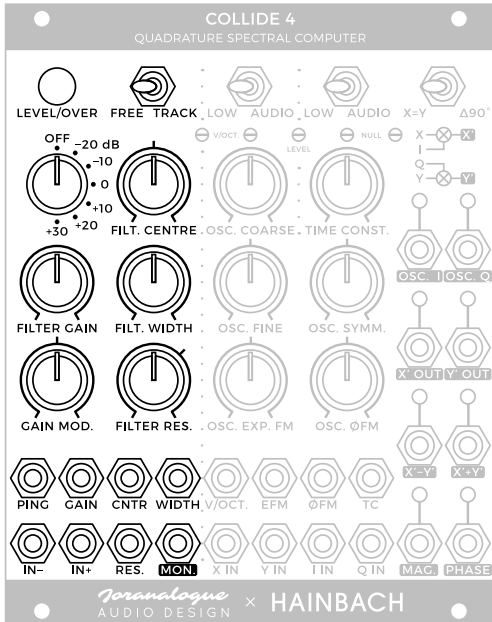

1 LEVEL/OVERLOAD INDICATOR

This LED visualises the status of the input section, which consists of the preamplifier, variable bandwidth filter and gain VCA. It will light up white, with variable intensity according to the amplitude of the filter's output signal.

Whenever clipping is detected anywhere within the input section signal path, the colour will immediately change to red. Overloads of this type do not cause any damage, but will result in audible distortion of the input signal.

2 FREE/TRACK SWITCH

After the preamplifier, the input signal is applied to the input of the variable bandwidth filter.

When this switch is set to the 'free' setting, the filter frequency can be freely adjusted. When set to 'track', it will follow the frequency of Collide 4's through-zero quadrature oscillator.

3 PREAMPLIFIER RANGE SWITCH

Using this rotary switch, the gain range of the input preamplifier can be adjusted in coarse steps between -20 dB ($\div 10$ attenuation) to +30 dB ($\times 30$ amplification). 0 dB is the unity gain setting. Turning the switch to the 'off' position mutes the input signal.

Attenuation is useful to avoid the possibility of strong signals clipping in the variable bandwidth filter, while amplification can be used to clip the signal on purpose as it enters the filter.

Note that despite the presence of a -20 dB range, Collide 4 is not designed to handle high input voltages. Do not apply signals outside the Eurorack voltage range of ± 12 V.

4 FILTER CENTRE FREQUENCY KNOB

The variable bandwidth filter is a special type of bandpass voltage-controlled filter (VCF), with an adjustable bandwidth.

In 'free' mode, the centre knob sets the centre frequency of the bandpass region, with a range of 22 Hz to 22 kHz.

In 'track' mode however, it sets the offset with respect to the VCO frequency, with 0 Hz offset when centred and 5 octaves of adjustment range in either direction.

As the diagram below shows, the centre and width parameters together determine the response of the variable bandwidth filter.

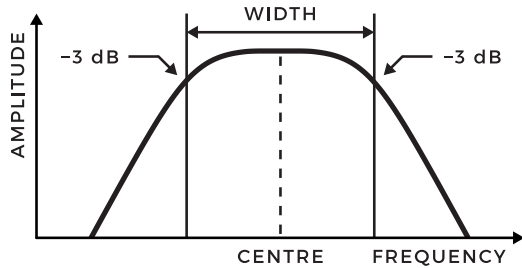

5 FILTER CENTRE FREQUENCY CV INPUT

This input is used to modulate the filter's centre frequency at 1 volt per octave.

Since the filter is temperature compensated, it will track a pitch sequence accurately and can be used as sine wave VCO when set to self-oscillate. The best pitch tracking performance is achieved at maximum resonance and medium width.

6 FILTER WIDTH KNOB

The width knob sets the bandwidth of the filter. In its minimum setting, the highpass and lowpass poles overlap, resulting in a standard 2-pole bandpass response, with -6 dB of attenuation at the filter frequency. As the width is increased, the poles will diverge, increasing the bandwidth and increasing the gain at the centre frequency to unity (0 dB).

When the frequency knob is centred and the width is set to maximum, the filter bandwidth will span between 22 Hz and 22 kHz, covering the entire audio range.

7 FILTER WIDTH CV INPUT

This CV (control voltage) input is used to modulate the filter bandwidth at approximately 1 volt per octave.

8 FILTER RESONANCE KNOB

The resonance knob controls a feedback path from the filter output back to the input, causing the filter's centre frequency to be emphasised. By increasing this parameter, the output will start to resonate at the centre frequency.

The diagram below shows how the filter response is altered by different resonance settings.

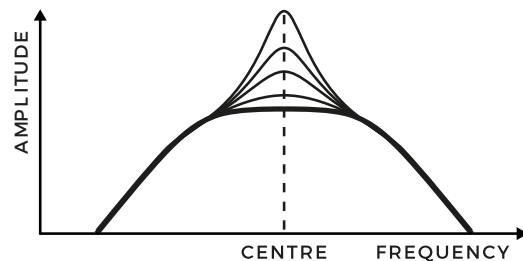

At sufficient filter width and resonance levels, self-oscillation will be achieved, turning the filter into a sine wave VCO.

A pip on the knob's scale denotes the typical level at which self-oscillation starts when the width parameter is set to maximum. Note though, that some amplitude variation under temperature change is to be expected.

Also, keep in mind that resonance will be reduced at narrow bandwidth settings, as the overlapping filter poles will start to attenuate the central part of the filter's bandwidth.

9 FILTER RESONANCE CV INPUT

The resonance amount can be modulated through this input, with +5 V corresponding to maximum resonance.

10 FILTER GAIN KNOB

This knob sets the total output gain of the variable bandwidth filter, by controlling a post-filter VCA. Unlike most synthesiser VCAs, it's specifically configured to provide amplification, rather than attenuation.

While the primary goal of this gain parameter is to provide as strong an undistorted signal as possible to the detector, it can also be pushed into clipping, providing post-filter overdrive. The knob ranges from 0 (unity gain) to +60 dB.

Applying increasingly more gain into deliberate overloads can be a powerful sonic effect. Sine waves are shaped into harmonically rich square wave, as the following diagram demonstrates.

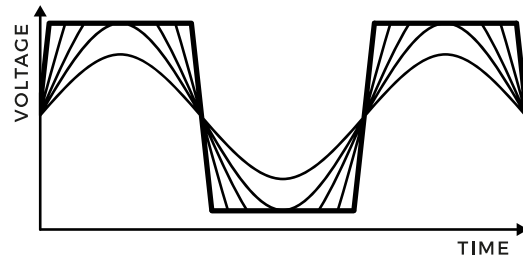

11 GAIN MODULATION INPUT AND KNOB

By applying a voltage to the gain CV input socket, the filter gain can be modulated at 12 dB/V. The corresponding modulation knob range is bipolar.

The range achievable through CV is larger than the knob range: -20 to +100 dB. Combined with the preamp gain setting, this results in a total input gain range of 130 dB!

12 DIFFERENTIAL SIGNAL INPUTS

The preamplifier is equipped with a differential AC-coupled input. This means that there are both positive and negative input sockets. The input signal to the preamp is formed by the voltage difference between these sockets.

This can also be regarded as two signal inputs to the preamp, summed together, with the negative input being inverted. Due to the AC coupling, only audio-rate signals are passed; any DC component is rejected. The AC coupling has a cutoff frequency of 16 Hz.

13 PING INPUT

Collide 4 includes a built-in transient generator to excite the input section—a most useful addition for creating ‘filter ping’ sounds.

To use this feature, set the preamplifier and filter to unity gain (switch to 0 dB, knob fully anticlockwise), and the filter resonance on the verge of self-oscillation.

A rising edge at the ping input, reaching above +3 V, will ‘strike’ the filter, creating a crisp percussive sound. The pitch, amplitude and decay time are set by the centre frequency, width, and resonance parameters. Experiment with different preamp and output gain settings to achieve a variety of timbres.

The diagram below shows a typical ‘filter ping’ output waveform.

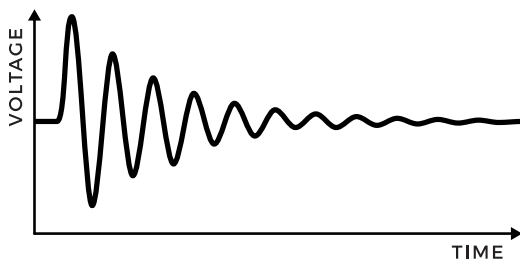

14 MONITOR OUTPUT

After the input signal has been processed through the preamp, variable bandwidth filter and gain VCA, the result can be listened to via this socket.

The label is a reference to the outputs found on laboratory lock-in amplifiers, where this feature allows the user to ‘monitor’ the pre-processed signal before it undergoes balanced modulation by the reference oscillator.

Note that since this output, as well as Collide 4’s other outputs, can have very high amplitudes, it might introduce clipping in modules downstream. Many modules from other brands are not designed to handle such strong signals, and their inputs will clip in a very unsatisfying way.

If this is the case, it is recommended to slightly attenuate Collide 4’s outputs first, to preserve their sonic integrity.

B OSCILLATOR

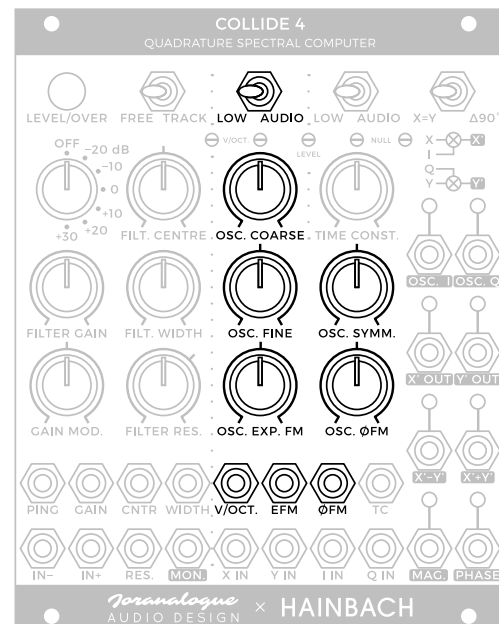

15 OSCILLATOR FREQUENCY RANGE SWITCH

This switch determines over which frequency range Collide 4's sine/cosine oscillator will operate: low frequency (VCLFO) or audio frequency (VCO). It also enables AC-coupling of the through-zero linear FM (frequency modulation) input when set to the audio range.

16 OSCILLATOR COARSE/FINE FREQUENCY KNOBS

The oscillation frequency of the oscillator is set by these knobs. In the audio frequency mode, with the fine knob centred and symmetry at maximum, the coarse knob has a range of 22 Hz to 22 kHz. The fine knob's range is 5 % of the coarse knob (6 semitones in audio mode).

In low frequency mode, the total range is 2.8 mHz (a period of 6 minutes) to 180 Hz, with 1 Hz when both knobs are centred.

17 VOLT PER OCTAVE FM INPUT

This input is used to modulate the oscillator frequency in an exponential fashion, with a standard 1 volt per octave response, to play accurate pitch. In the low range, the sensitivity is increased to approximately 0.66 volt per octave.

18 EXPONENTIAL FM INPUT AND KNOB

The exponential FM input includes a polariser knob to set the modulation depth, with 0 in the centre, +1 volt per octave maximum and -1 volt per octave minimum in audio mode. In low mode, the sensitivity is increased to approximately 0.66 volt per octave.

19 OSCILLATOR SYMMETRY KNOB

Since the oscillator is capable of through-zero frequency modulation (TZFM or Φ FM), the symmetry knob is an important control which determines the range over which the TZFM occurs.

When set to the centre position, the oscillator will stop. External TZFM must be applied for oscillation to start again, with positive voltage corresponding to positive frequencies and vice versa. This is known as symmetrical TZFM.

However, if the knob is moved away from the centre in either direction, the TZFM becomes asymmetrical. In either the minimum or maximum setting, it will provide purely in-tune modulation, similar to the regular linear FM input on a typical sine wave oscillator, but with much greater range (and quadrature outputs). In this configuration, the oscillator can still go through-zero, but this will require modulation voltages beyond ± 5 V.

When not using external TZFM, this knob simply provides linear frequency control, with both the positive and negative frequency domains available. It is especially useful when Collide 4 is being used as a frequency shifter, making it easy to smoothly transition between down and up shifting though the zero point, simply by turning a single knob.

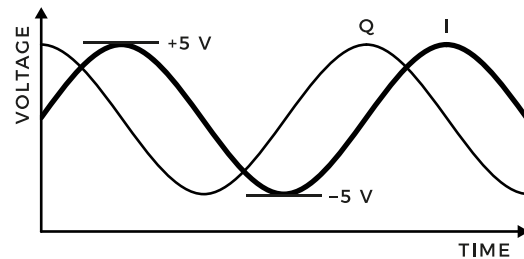

20 OSCILLATOR THROUGH-ZERO FREQUENCY MODULATION KNOB AND CV INPUT

The oscillator's frequency is modulated linearly via this CV input. The matching knob sets the modulation depth. It is a polariser control, so the modulation signal will be inverted if the knob is set anywhere in the left half of its range.

The TZFM CV input is AC-coupled when the oscillator is running in the audio range, rejecting any DC offset in the modulation signal that may cause a perceived pitch shift. In the low frequency range, it is DC-coupled.

21 OSCILLATOR OUTPUTS

Both output signals of the oscillator are available via these output sockets. They are low-distortion, 10 Vpp sine waves with a quadrature (90°) phase relationship—or, more correctly, a sine and cosine wave pair. They are labelled I and Q, which stands for 'in-phase' and 'quadrature'.

The LEDs at the output sockets show the real-time output voltages, lighting up red for positive and blue for negative.

C DETECTOR

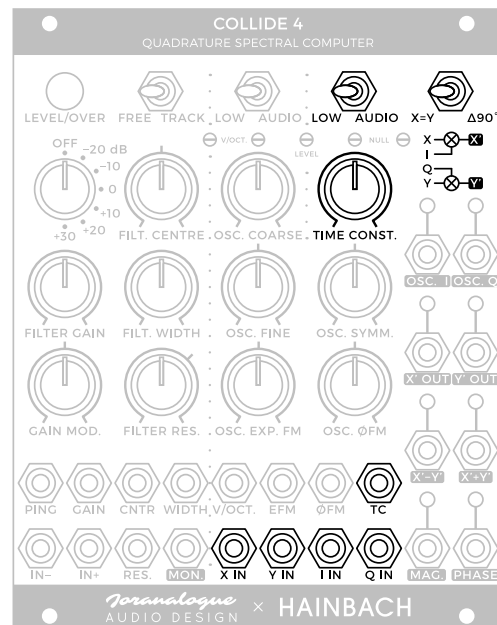

22 HILBERT TRANSFORM SWITCH

Collide 4 contains a precision Hilbert transform network, also known as a Dome filter. This is a special circuit, not found in any vintage lock-in instruments, which creates two phase-displaced copies of an incoming signal. It does this while keeping timbre and amplitude information over the entire spectrum intact.

When this switch is in the 'X=Y' setting, the Hilbert network is bypassed, and the monitor signal is applied unchanged to both balanced modulators; X and Y are identical.

When it is set to 'Δ90°', the Hilbert network is enabled, which results in a 90° phase difference between X and Y. This allows Collide 4 to function as a frequency shifter.

The diagram below shows the resulting waveform when multiplying two sine waves at different frequencies.

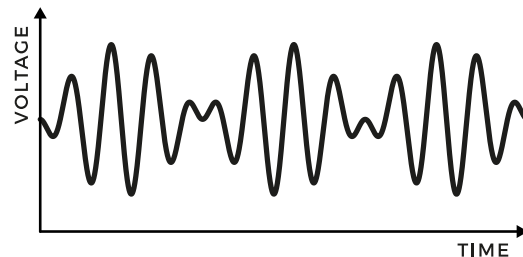

23 BALANCED MODULATOR INPUTS

Following the Hilbert transform network are two balanced modulators, also known as ring modulators. They perform precision analogue multiplication of the input signals.

$$X' = (X \times I) \div 5 \text{ V} \quad \text{and} \quad Y' = (Y \times Q) \div 5 \text{ V}$$

The X/I and Y/Q inputs are interchangeable, and the 5 V scale factor sets the gain to unity when either input voltage is 5 V.

Collide 4 uses high-quality integrated circuit multipliers, creating minimal unwanted distortion. Analogue multipliers of this type are also referred to as bipolar VCAs or 4-quadrant multipliers.

By default, they are fed by the input section and the oscillator. However, it is possible to override these normalised connections by plugging cables into these sockets.

This makes it possible to perform further processing on the input section before the multiplication process takes place, or to simply use the balanced modulators separate from the input section and oscillator.

24 TIME CONSTANT FREQUENCY RANGE SWITCH

Directly following the modulators are a set of 2-pole lowpass filters, providing a -12 dB/octave roll-off. The frequency range of the filters can be selected using the range switch.

In audio frequency mode, the filter frequency can be adjusted between 22 Hz and 22 kHz. In low mode, the range is 150 mHz to 150 Hz.

25 TIME CONSTANT KNOB

The cutoff frequencies for both filters are always identical and are controlled by the time constant parameter.

When performing lock-in measurements, these filters serve to filter out all high frequency content, leaving only the average DC part of the signal remaining. In practical synthesis use, they simply provide added control over the timbre of the outputs.

Note that the operation of this knob is reversed compared to vintage lock-in amplifiers. Turning down the knob will decrease the filter frequency, as is most common in music synthesisers.

26 TIME CONSTANT CV INPUT

The time constant CV socket is used to modulate the output filters at approximately 1 V per octave.

D OUTPUT SECTION

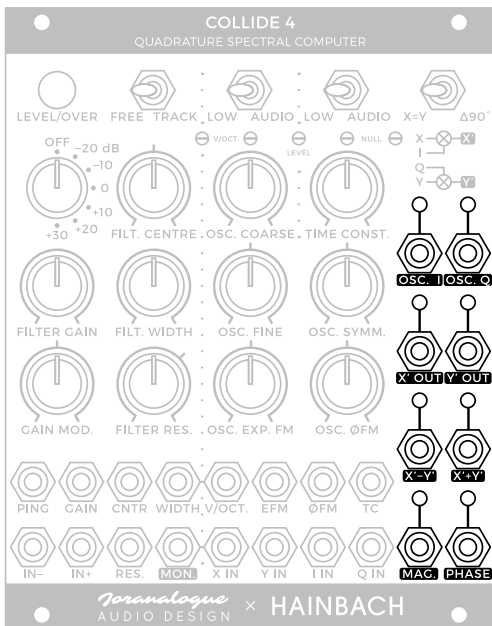

27 X' AND Y' OUTPUTS

In contrast to most vintage units, Collide 4 has two main outputs, thanks to its dual-phase (quadrature) topology. The individual output signals of the low-pass filters are available directly at the X' and Y' sockets.

28 SUM AND DIFFERENCE OUTPUTS

These are the sum (X'+Y') and difference (X'-Y') of the detector outputs. When the module is being used as a frequency shifter, this is where the down- and up-shifted output signals are found.

29 MAGNITUDE AND PHASE OUTPUTS

The X' and Y' signals can be considered to represent the Cartesian coordinates of a vector. Polar conversion circuitry is used to calculate the magnitude and phase parameters from these coordinates.

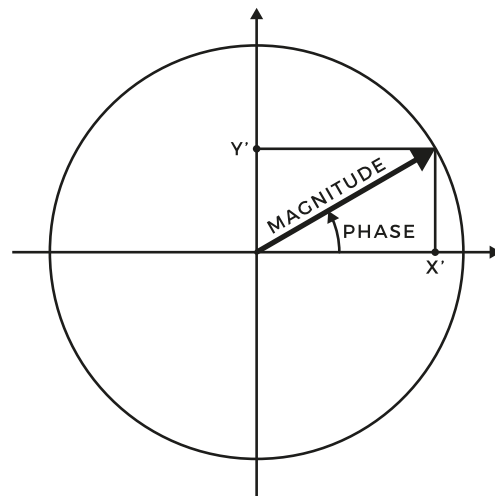

The magnitude of the vector is expressed directly in voltage, and is computed by Pythagorean addition:

$$r = \sqrt{X'^2 + Y'^2}$$

As it's the result of a square root operation, the output will always be a positive voltage. The absolute values of both the X' and Y' voltages contribute to the final magnitude voltage.

The vector's phase is calculated using the arctangent function:

$$\theta = \arctan (Y' \div X')$$

It is represented by a 18°/V voltage output, with full 360° coverage. This gives the output a range of -10 to +10 V.

As the next diagram shows, the voltage segment in which the phase output operates, depends on the polarity of the X' and Y' signals. The final phase voltage then depends on the ratio of Y' to X'; not on their exact voltages.

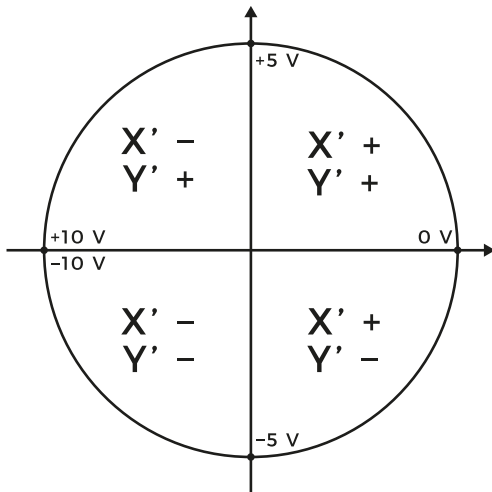

For example, if X' and Y' are both positive and equal in voltage, this represents a phase angle of 45°, corresponding to a phase output voltage of +2.5 V.

Note that at 180°, where X' is negative and Y' is 0 V, the positive and negative angle domains meet, and the output voltage might switch rapidly between -10 and +10 V.

Also, since the phase output is always calculating the angle of the (X', Y') vector, it might provide unexpected results when these signals are very weak or absent, as it will be responding in real time to spurious noise. This is normal behaviour.

These operations are performed using high-speed analogue electronics, capable of processing DC as well as audio rate signals precisely.

An understanding of the underlying mathematics is not required—the phase/magnitude outputs can be used simply as interesting wave-shaping/distortion effects. However, they do allow some advanced patching techniques for the adventurous modularist.

E CALIBRATION

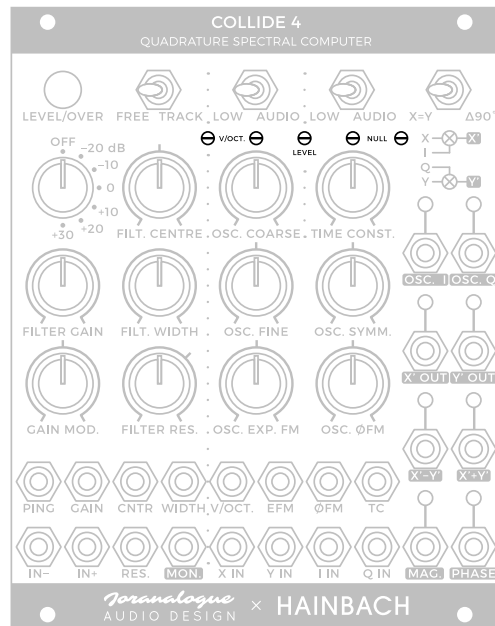

30 VOLT PER OCTAVE TRIMMERS

These trim potentiometers are used to calibrate the pitch tracking of the variable bandwidth filter (left) and oscillator (right). Since they are accessible from the front panel, calibration can be easily performed without removing the module from the system. Each module is individually calibrated during production; do not adjust any trimmers if not needed.

Should you find your Collide 4's filter to be out of tune, set the preamplifier to the 'off' position, the filter gain to minimum, the centre frequency knob to about 20 % of its range (9 o'clock), the width knob centred and the resonance to maximum.

Make sure Collide 4 has been powered for at least 20 minutes at a stable ambient temperature. Now connect the monitor output to a calibrated digital tuner.

During the tuning process, the volt per octave input should be continually switched between 0 V and a precision +5 V source, toggled automatically or by hand. Leave all other inputs unpatched.

Using a dedicated trimming tool or standard 2.5 mm flat screwdriver, adjust the left-hand V/oct. trimmer until the interval between both states is exactly 5 octaves. For example, if 0 V corresponds to a pitch of C1 + 23 cents, +5 V should yield C6 + 23 cents.

To calibrate the oscillator's volt per octave response, the same basic procedure is used as when calibrating the filter.

After the 20-minute warm-up period, set the oscillator to the audio range, with the coarse knob to about 20 %, fine centred and symmetry to the maximum setting. Connect the tuner to the I or Q output and adjust the right-hand V/oct. trimmer as needed.

31 OSCILLATOR LEVEL TRIMMER

This trim potentiometer sets the amplitude of the oscillator. Use the same settings as for the V/oct. calibration procedure and display the I or Q output signal on an oscilloscope. Adjust the trimmer until the sine wave's amplitude is exactly 10 Vpp.

Although the volt per octave tracking is temperature-compensated, the amplitude is not. It will change slightly with ambient temperature, like a self-oscillating filter. If an exact 10 Vpp amplitude is needed, recalibrate this trimmer whenever the temperature changes.

At low settings of this trimmer, Collide 4's oscillator will not be able to start up. If your VCO does not appear to be functioning, an improperly adjusted level trimmer is most likely the reason why.

32 NULLING TRIMMERS

These trim potentiometers are used to trim out any small imbalances in the balanced modulators, which would otherwise cause the oscillator to bleed into the output. There is one for each channel: the left-hand trimmer controls the nulling of X' nulling, and the right hand one controls Y'.

To adjust this parameter, switch the pre-amplifier off and set the oscillator to approximately 1 kHz (symmetry maximum, coarse and fine centred). Listen to the proper output (X' or Y') and turn the corresponding trimmer until the oscillator is no longer audible.

PATCH IDEAS

STEREO COMPLEX OSCILLATOR

'Complex oscillator' is a common term in modular synthesizers for a particular style of dual VCO module, with extensive modulation options. Since Collide 4 contains a self-oscillating filter, through-zero quadrature VCO and two ring modulators, it can easily be patched to fill this role.

Set the pre-amplifier to its 'off' setting, filter in free mode, with gain to unity (minimum) and both frequency centre and width in the halfway position. While listening to the monitor output, turn up the filter resonance until you hear a sine wave.

You can now use the monitor output as a 'modulator' signal to modulate the frequency, either exponentially or through-zero linearly, of the 'carrier' oscillator. Simply patch the monitor output to the appropriate CV input of the oscillator, and use either the I or Q output, or both together to obtain dramatic stereo effects.

Using track mode, the self-oscillating filter and the oscillator can be modulated at 1 V/octave together, to keep the perceived pitch in tune when playing a sequence.

To obtain further timbres, experiment by adding the balanced modulators, pinging the input filter, using the magnitude/phase outputs, feedback patching...

FREQUENCY SHIFTER

Another application for Collide 4 is as a frequency shifter. This is an audio effect which shifts the entire spectrum of an input signal by a certain amount. As this moves all harmonics linearly across the spectrum, their exact ratios are lost, often resulting in inharmonic sounds. The sonic effects can be quite dramatic and inspiring.

In this use case, an externally applied input signal is shifted by the frequency set by the oscillator. The human voice is a particularly useful source, as the effects of frequency shifting on speech are readily heard, but anything from drums or lead sounds to acoustic instruments can yield interesting results.

Apply the input signal to the preamplifier input and set the filter settings appropriately. Usually, you'll want to start with both gain stages at unity and the filter fully open (free mode, centred frequency, maximum width, no resonance). Also make sure that the detector filters are fully open (time constant knob to maximum).

Set the Hilbert transform switch to the ' $\Delta 90^\circ$ ' position and listen to either the X'-Y' or X'+Y' output. While adjusting the oscillator frequency, you should hear the changes in the frequency shift.

Each output will shift the input signal in a different direction, and the symmetry knob allows you to flip the directions around by shifting through zero.

Setting the Hilbert switch to 'X=Y' will result in ring modulation-type sounds, as in that case both the up and down shifted spectra are present in the output simultaneously.

Finally, note that frequency shifting is distinct from pitch shifting, which is a different effect that keeps the relationship between harmonics.

DUAL TONE SINE OSCILLATOR

This patch is similar in principle to the frequency shifter, except no external input is used. Instead, the variable bandwidth filter is configured to self-oscillate.

With filter gain set to minimum and the width knob in its halfway position, turn up the filter resonance until self-oscillation is achieved. With the mode switches set to 'track', ' $\Delta 90^\circ$ ' and both frequency ranges set to audio, listen to both the X'-Y' and X'+Y' outputs as a stereo pair. You should hear two different sine tones in the left and right ear.

Both sine waves can be modulated together using the VCO's various CV input sockets. Experiment with the filter gain and time constant parameters to adjust the timbre.

The interval between them is set by the filter offset, with respect to the reference oscillator. This parameter is set by the centre knob and can also be modulated accurately using the centre CV input.

Interesting binaural effects can be created using modulation of the various parameters. A mix of both sine waves can be heard from the individual X' and Y' outputs.

PERCUSSION SYNTHESISER

Since the magnitude output is always positive, it can be used to create a signal that follows the signal envelope. This, together with the ping input, allows Collide 4 to function as a bass drum synthesiser, without the need for any other modules.

Apply a trigger signal to the ping input and set the filter to the edge of self-oscillation. Set the filter and oscillator frequencies to 9 o'clock, and the oscillator symmetry fully maximum.

Now, patch a cable between the magnitude and through-zero FM inputs and apply maximum negative modulation using the associated knob. Listen to the X'-Y' or X'+Y' output.

Many parameters are available to change the timbre of the percussive sound: the filter/oscillator frequencies, amount of modulation as well as preamplifier gain, filter output gain, time constant and use of the Hilbert network will all have a pronounced effect on the bass drum sound. Higher frequencies allow the synthesising of bell, bongo, or tom sounds.

HOW LOCK-IN AMPLIFIERS WORK

WILL IT SCIENCE?

While Collide 4 has been designed with musical applications in mind, it is based on the same principles as laboratory lock-in amplifiers. This means that it can in fact be used to perform lock-in amplitude and phase measurements of (very weak) signals.

In this chapter, we will explore using Collide 4 for this purpose, and in which ways it resembles and deviates from classic analogue lock-in instruments.

Although a deep technical understanding of the lock-in amplifier's operation is not needed to use Collide 4 in a musical context, it can greatly enhance your command over the module's full sound design capabilities.

We will discuss the basic elements of the lock-in signal path: the input channel, reference channel and synchronous detection process, and how Collide 4's internal circuits resemble and differ from those found in its vintage brethren.

It should be noted though that Collide 4 is in no way designed, certified, or guaranteed suitable for laboratory use. Do not base your PhD thesis upon its operation.

ARCHITECTURE

Let's begin by examining the basic architecture of a lock-in amplifier.

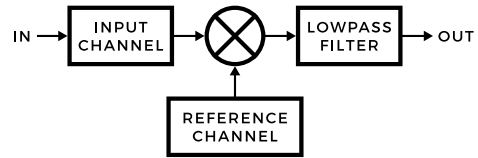

An external input signal is processed by the input channel and multiplied with the reference channel. The result, after lowpass filtering, is available from the output.

REFERENCE CHANNEL

In most vintage lock-in amplifiers, the reference channel is a simple sine wave oscillator, with a fixed phase external output, and an adjustable phase channel to the synchronous detector.

It is a built-in signal source that provides a signal that can be applied to the sample or 'test object' in an experiment, using a transducer. It can usually be overridden by an externally applied signal through a dedicated input socket.

In a practical experiment, the transducer and sensor, which picks up the response, could be optical, vibrational, ultrasound...

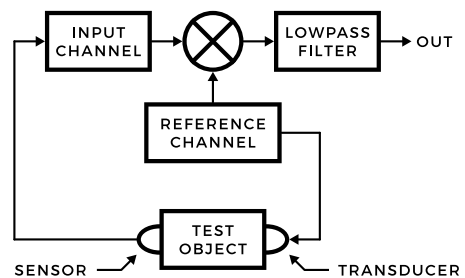

In Collide 4, the reference channel is simply called the oscillator, and it consists of a quadrature VCO. This means that its two outputs (I and Q) are identical sinusoidal signals, with identical amplitudes, but a fixed phase separation of 90°—or, in other terms, a sine and cosine output pair.

INPUT CHANNEL

The pre-amplifier, variable bandwidth filter and gain VCA form Collide 4's analogue to the input channel on a lock-in amplifier instrument. However, to avoid confusion with the concepts of stereo and mixing channels in audio, the term 'input section' is used instead.

The goal of these subcircuits is to pre-condition the received signal from the experiment to get the best possible measurements further down the circuit.

The pre-amplifier applies gain, making the—often weak—input signal as strong as possible while still avoiding clipping; the filter cuts out frequencies below and above the reference frequency; and the filter's output gain amplifies the signal again to obtain the best possible signal fidelity.

On Collide 4, the signal/overload LED and monitor output make it easy to judge whether the input signal has been properly conditioned. Distinct overload lights are a common feature on vintage lock-in amplifiers, as any signal overloads would invalidate the final measured value.

SYNCHRONOUS DETECTOR

The concept of synchronous detection makes lock-in amplifiers exceptionally powerful, as it allows them to detect extremely weak signals that are buried in the noise floor.

To achieve this, the reference and pre-processed input signals are multiplied. In Collide 4, a true analogue multiplier ('balanced modulator' or 'ring modulator') is used for this, while most lock-in instruments use a simpler chopping circuit, typically referred to as the synchronous detector.

Since the lock-in detection process is phase-sensitive, adjustable detector phase is a key feature on many vintage lock-in instruments.

In contrast, Collide 4 takes a quadrature approach, determining the input's phase relationship to both I and Q components of the reference signal. This means that there are in fact two analogue multipliers: the signal is multiplied with both I and Q separately.

The result of the multiplication operation is that any spectral content at the reference frequency (as well as its harmonics), present in the input signal, will result in a positive average output voltage. The exact voltage is determined by the phase relationship between the input and reference, signal lost in the experiment, and gain applied by the input channel.

To extract this average voltage so it can be easily measured, lock-in amplifiers use a lowpass filter after the detector. Its cutoff frequency, or more precisely its cutoff period, is known as the detection time constant.

The goal of this filter is to extract the average DC value, while maintaining a reasonably fast response to changes in the input signal or lock-in settings.

The following diagram shows the results of multiplication and filtering when both input and reference signals are identical.

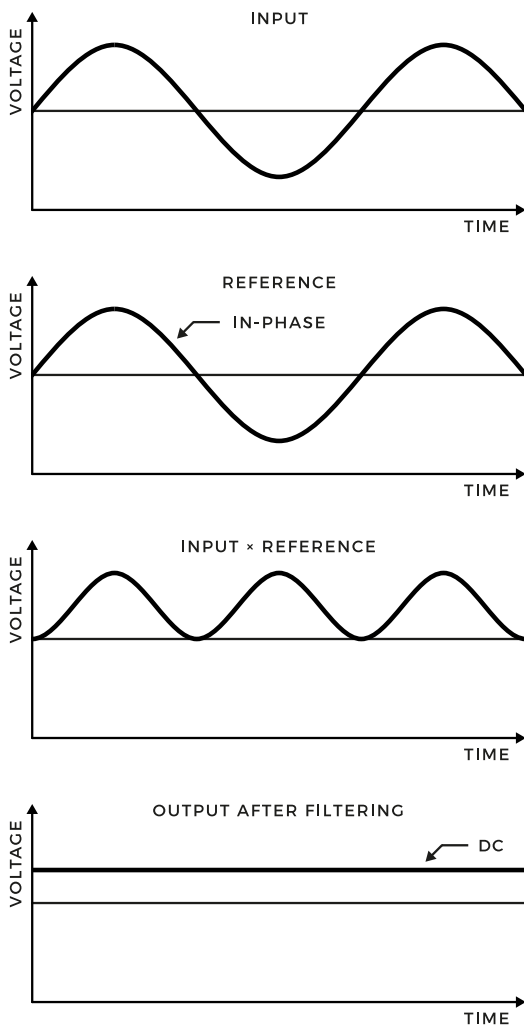

As can be seen, the result of the multiplication process is a sine wave at double the input/reference frequency, with a DC offset. After filtering, only the DC voltage remains, which is equivalent to one quarter of the input AC amplitude in V_{pp} .

Note that a negative DC output value is the result of the input and reference being in anti-phase, with exactly 180° yielding the maximum negative voltage.

In contrast, the diagram below shows the same operation when the input and reference voltages are 90° out of phase.

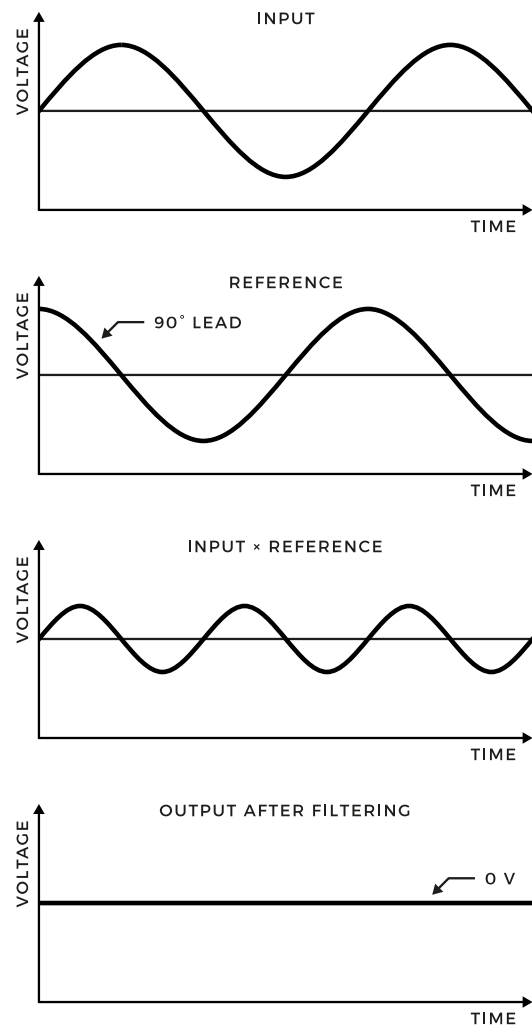

In this case, the multiplication result no longer has a DC offset, so the output voltage after filtering is 0 V, highlighting the phase-dependency property of the synchronous detection process.

Similarly, if the input and reference signals are different frequencies, the resulting average DC value is 0 V. Hence, a lock-in amplifier can be thought of as an extremely selective, phase-sensitive bandpass filter, rejecting all spectral components in the input signal, except those with identical frequency and phase to the reference.

Since the examples above show the reference signal at both 0° and 90°, this means that both example operations are performed in parallel thanks to Collide 4's dual-phase topology. The two results are available from the X' and Y' outputs.

By putting everything together, adding the second multiplication path to the basic lock-in amplifier, we've now arrived at the dual-phase lock-in amplifier. This is Collide 4's core architecture.

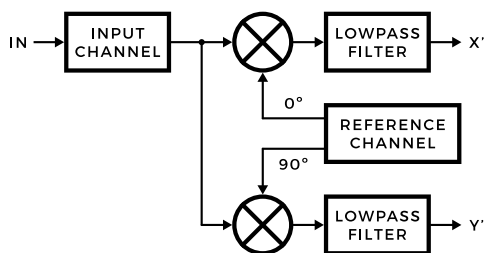

While Collide 4 also contains a Hilbert transform network, it is not used in lock-in applications, so is not discussed here.

POLAR CONVERTER

Direct outputs are available for both X' and Y' multiplication results, as well as their sum and difference. In the lock-in application however, the outputs most of interest are the magnitude and phase signals.

The DC voltage at the magnitude output will represent how much signal is present in the input channel at the reference frequency, regardless of phase. When reading it, keep in mind to compensate for any gain applied in the input channel. Then, multiply the figure by four to obtain the signal amplitude in V_{pp} .

Meanwhile, the phase output represents the phase relationship between the input and reference I signals, with 0 V indicating that they are in-phase.

Among analogue lock-in amplifiers, Collide 4 is unique in providing magnitude and phase readings. Since vintage units do not have this dual-phase topology, they rely on the operator adjusting the phase knob manually to determine the magnitude and phase. However, it is a standard feature on modern digital lock-in instruments, used daily in laboratories around the world.

While the concepts discussed here might appear far removed from any musical application, the truth is that the sonic artist and experimental physicist are closely related creatures. Deep knowledge of the tools available, combined with a willingness to experiment and explore, is what yields the best results for both.

SPECIFICATIONS

MODULE FORMAT

Doepfer A-100 'Eurorack' compatible
3 U, 20 HP, 30 mm deep (including
power cable)

Milled 2 mm aluminium front panel
with non-erasable graphics

MAXIMUM CURRENT DRAW

+12 V: 200 mA

-12 V: 200 mA

POWER PROTECTION

Reverse polarity (MOSFET)

I/O IMPEDANCE

All inputs: 100 k Ω

All outputs: 0 Ω (impedance compen-
sated)

OUTER DIMENSIONS

128.5 x 101.3 x 43 mm (H x W x D)

MASS

Module: 295 g

Inc. packaging and accessories: 405 g

SUPPORT

As all Joranalogue Audio Design prod-
ucts, Collide 4 is designed, manufac-
tured, and tested with the highest
standards, to provide the performance
and reliability music professionals ex-
pect.

In case your module isn't functioning as
it should, make sure to check your Euro-
rack power supply and all connections
first.

If the problem persists, contact your
dealer, or send an email to [support@jo-
ranalogue.com](mailto:support@jo-
ranalogue.com). Please mention your se-
rial number, which can be found on the
product card or on the module's rear
side.

ACKNOWLEDGEMENTS

With compliments to the following fine people,
who helped to make Collide 4 a reality!

Stefan 'Hainbach' Goetsch
Andrew Huang
Ben 'DivKid' Wilson
Bernhard Rasinger
Björn Jauss
Boris 'Jogging House' Potschubay
Boris Uytterhaegen
Daniel Miller
Erwin Van Looveren
Frits Jacobs
Hannes d'Hoine
Jamie Lidell
Janus Coorevits
Konstantinos Fioretos
Kris Vanderheyden
Lieven Stockx
Pim Gombeer
Quincas Moreira
Sam 'LOOK MUM NO COMPUTER' Battle
Simon 'BRiES' De Rycke
Tom Churchill
Wim Verheyen
Ziv 'Loopop' Eliraz

Collide 4 User Manual
version 2024-10-09

© 2024. All rights reserved.
Errors and omissions excepted.

info@joranalogue.com
<https://joranalogue.com/>

**LAB GRADE
SYNTHESIS.**

EST. 2016
FLANDERS FIELDS
BELGIUM