

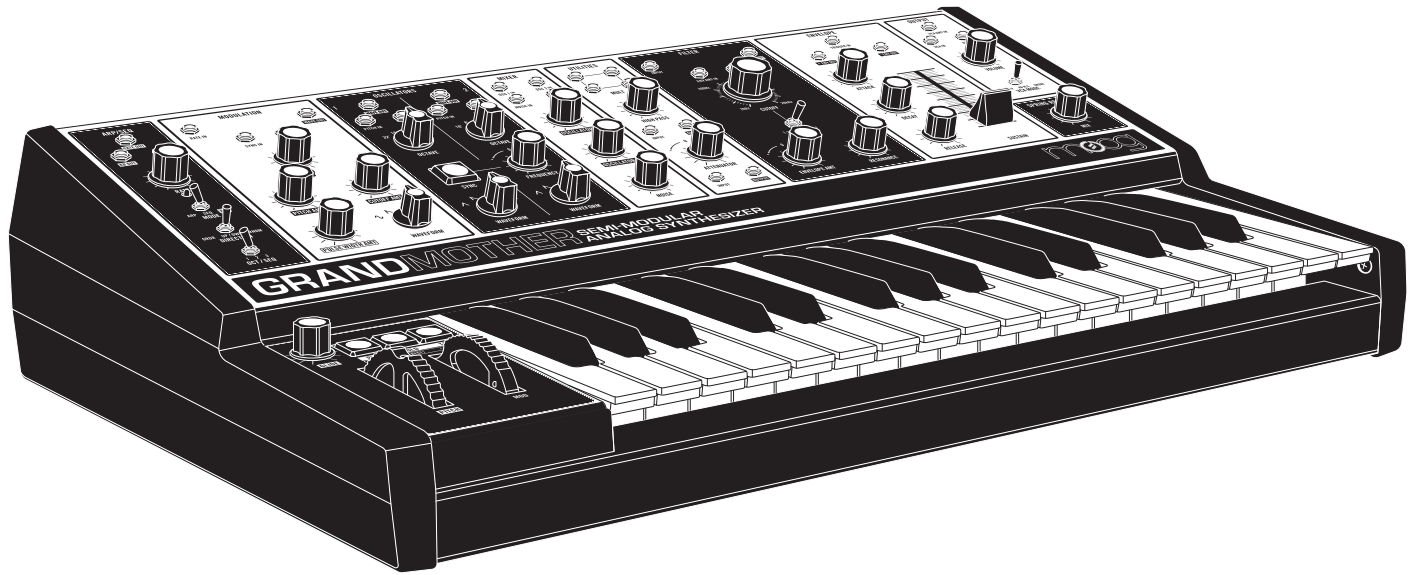

GRANDMOTHERTM

USER'S MANUAL



“Everything has some consciousness,
and we tap into that. It is about
energy at its most basic level.”

- **Dr. Robert Moog** -

IMPORTANT SAFETY INSTRUCTIONS

WARNING - WHEN USING ELECTRIC PRODUCTS, THESE BASIC PRECAUTIONS SHOULD ALWAYS BE FOLLOWED:

1. Read all the instructions before using the product.
2. Do not use this product near water - for example, near a bathtub, washbowl, kitchen sink, in a wet basement, or near a swimming pool or the like.
3. This product, in combination with an amplifier and headphones or speakers, may be capable of producing sound levels that could cause permanent hearing loss. Do not operate for a long period of time at a high volume level or at a level that is uncomfortable.
4. The product should be located so that its location does not interfere with its proper ventilation.
5. The product should be located away from heat sources such as radiators, heat registers, or other products that produce heat. No naked flame sources (such as candles, lighters, etc.) should be placed near this product. Do not operate in direct sunlight.
6. The product should be connected to a power supply only of the type described in the operating instructions or as marked on the product.
7. The power supply cord of the product should be unplugged from the outlet when left unused for a long period of time or during lightning storms.
8. Care should be taken so that objects do not fall, and liquids are not spilled, into the enclosure through openings.

There are no user serviceable parts inside. Refer all servicing to qualified personnel only.

NOTE: This equipment has been tested and found to comply with the limits for a Class B digital device, pursuant to Part 15 of the FCC rules. These limits are designed to provide reasonable protection against harmful interference in a residential installation. This equipment generates, uses, and can radiate radio frequency energy and, if not installed and used in accordance with the instructions, may cause harmful interference to radio communications. However, there is no guarantee that interference will not occur in a particular installation. If this equipment does cause harmful interference to radio or television reception, which can be determined by turning the equipment off and on, the user is encouraged to try to correct the interference by one or more of the following measures:

- Reorient or relocate the receiving antenna.
- Increase the separation between the equipment and receiver.
- Connect the equipment to an outlet on a circuit different from that to which the receiver is connected.
- Consult the dealer or an experienced radio/TV technician for help.

CAUTION: Please note that any changes or modifications made to this product not expressly approved by Moog Music Inc. could void the user's authority granted by the FCC to operate the equipment.

TABLE OF CONTENTS

06 UNPACKING & INSPECTION

06 SETUP & CONNECTIONS

07 INTRODUCTION

07 GRANDMOTHER OVERVIEW

08 SIGNAL FLOW

08 FEATURES & CONTROLS

08 KEYBOARD

09 LEFT-HAND CONTROLLER

10 OSCILLATORS

14 MIXER

16 FILTER

18 ENVELOPE (ADSR)

20 OUTPUT

23 MODULATION

25 UTILITIES

27 ARP / SEQ

31 SEQUENCER - GETTING STARTED

34 REAR PANEL

34 FINE TUNE

34 AUDIO

35 ARP / SEQ CV

36 MIDI

37 GLOBAL SETTINGS

37 CHANGING THE MIDI CHANNEL

37 MIDI CLOCK SETUP

37 LOCAL ON / OFF

37 NOTE PRIORITY

38 PITCH BEND RANGE

38 EXTERNAL CLOCK MODE

38 EXTERNAL CLOCK INPUT PPQN

38 CLOCK OUTPUT PPQN

39 PATCH POINT INDEX

39 FRONT PANEL

42 REAR PANEL

43 MIDI DOCUMENTATION

45 PRESETS

52 BLANK PRESET SHEETS

53 WARRANTY

54 SPECIFICATIONS

55 SERVICE & SUPPORT INFORMATION

UNPACKING & INSPECTION

Check the contents of the shipping carton.

Be careful when unpacking your new Moog Grandmother® so that nothing is lost or damaged. Moog recommends saving the carton and all packing materials in case you ever need to ship the instrument for any reason.

The Grandmother ships with the following items:

1. Grandmother Semi-Modular Analog Synthesizer
2. Power Supply
3. Owner's Manual
4. Patch Cables
5. Registration Card

What you will need:

1. A table or surface where you can set your Grandmother.
2. A 1/4" instrument cable and amplified speaker or headphones with a 1/4" plug.
3. A properly wired AC outlet.

SETUP & CONNECTIONS



POWER

Plug the included power adapter into the 12VDC power jack on the back of your Grandmother.

NOTE: The Grandmother's universal power supply will operate with a power source from 100 to 240 Volts AC, 50/60Hz.

Plug the other end of the included power adapter into an AC outlet.

NOTE: Your Grandmother is an analog instrument and should be allowed 10-15 minutes to warm up before use. In cases where it has been left in a cold car overnight, for example, it may take as long as 25 minutes before oscillator tuning has stabilized. Do not operate Grandmother in direct sunlight.

AUDIO OUT / HEADPHONES

With the Master **VOLUME** control turned all the way down, plug one end of a 1/4" (TS) instrument cable into Grandmother's **AUDIO OUT** jack on the rear panel.

Plug the other end into an amplified speaker or mixing console input. This jack can also be used with a set of mono or stereo headphones.

WARNING: Do not use a TRS (balanced) cable for line output applications as this will cause phase cancellation and a very weak signal.

GRANDMOTHER OVERVIEW

Grandmother is a sonic playground that harkens back to Moog's modular roots, where synthesis is not only about the end result, but also the journey of discovery and experimentation. While capable of highly complex sounds and modulation, Grandmother's semi-modular design requires absolutely no patching, ensuring that human beings of any skill level can easily explore and experience the joys and magic of analog synthesis.

Inspired by the classic Moog modular synthesizers that came before it, Grandmother's sound engine, modulation engine, and onboard spring reverb tank are completely analog, resulting in an unrestricted sonic vocabulary of immeasurable beauty and power. In addition, Grandmother also features an easy-to-use Arpeggiator and Sequencer for added enjoyment and programmable syncopation.

Though not required, creative patching and exploration are the keys to discovering exciting new relationships between modules and to truly unlocking Grandmother's infinite expanse of auditory inspiration. Patching can also be used to override internal connections, allowing each section to function just as an independent module would.

In addition to its standalone function, Grandmother is also an ideal analog audio processor for external sound sources, and a powerful keyboard front end for expanding a Mother-32, DFAM, or any Eurorack modular system.

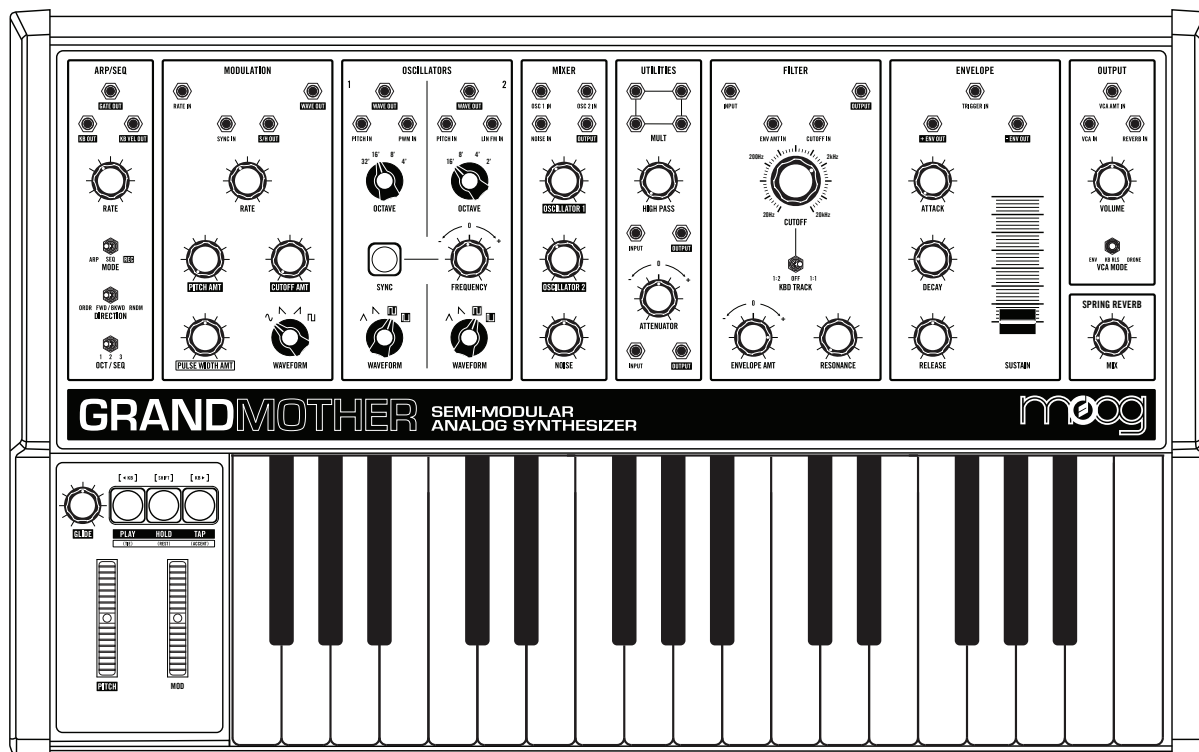

PERFORMANCE

32-note keyboard with arpeggiator and a 256-note sequencer with three sequence locations

SOUND SOURCES

Two voltage-controlled oscillators with hard sync and a white noise generator

ANALOG EFFECTS

6" spring reverb tank

SOUND BLENDING

3-channel mixer with an additional 1/4" external audio input

SOUND SHAPING

Classic 4-pole 10Hz to 20kHz Ladder filter and a patchable 1-pole high pass filter

UTILITIES

Patchable 4-point mult and a bipolar attenuator

DYNAMICS

Analog ADSR envelope

MODULATION

Wide-range analog LFO with Sync input and a Sample/Hold output

PATCH POINTS

41 patch points with 21 inputs and 20 outputs

SIGNAL FLOW

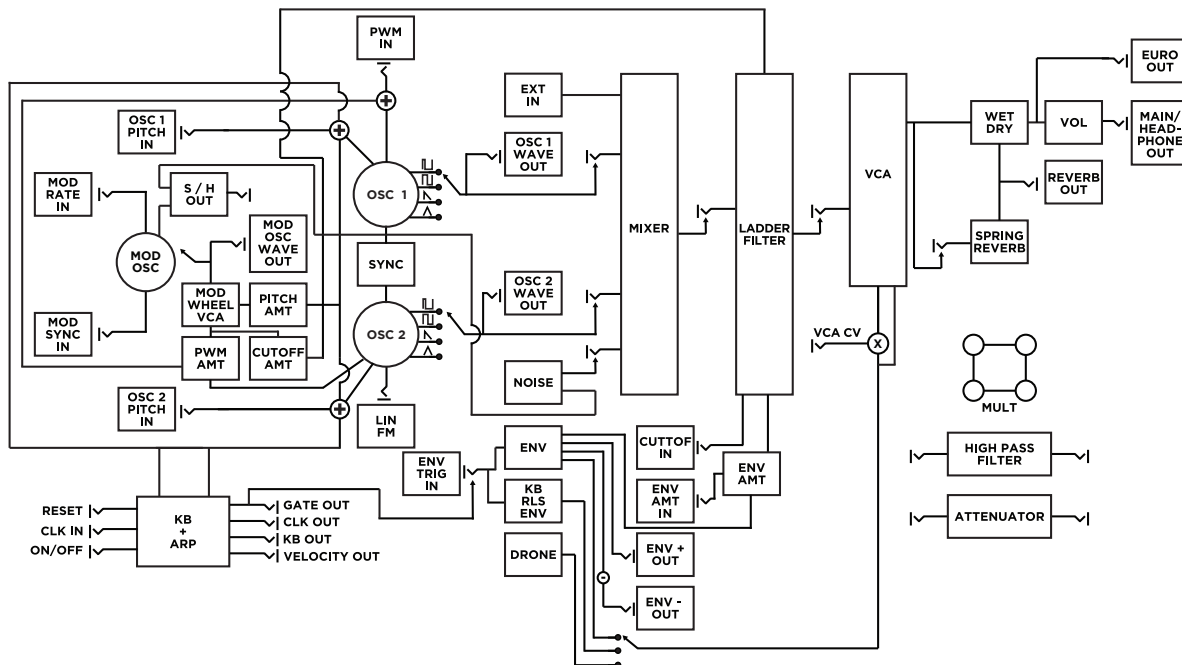

FEATURES & CONTROLS

Grandmother groups panel controls together by module. Each module is also equipped with a set of modular patch points which greatly extend the capabilities of this expansive analog instrument.

■ KEYBOARD

Grandmother is equipped with a 32-note velocity-sensitive keyboard.

NOTE: There is no internal routing for keyboard velocity, but a connection can easily be made from the **KB VEL OUT** to the **CUTOFF IN** patch point in the Filter section.

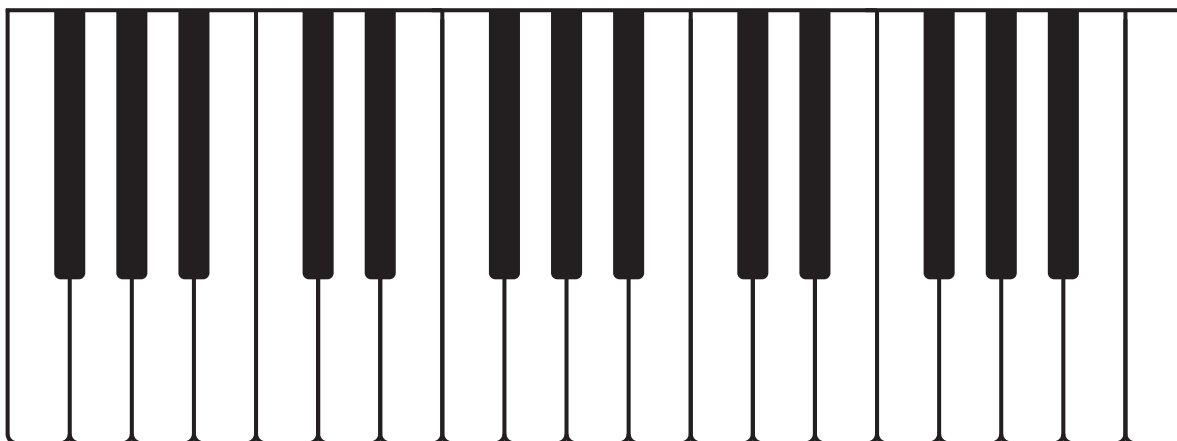

■ LEFT HAND CONTROLLER

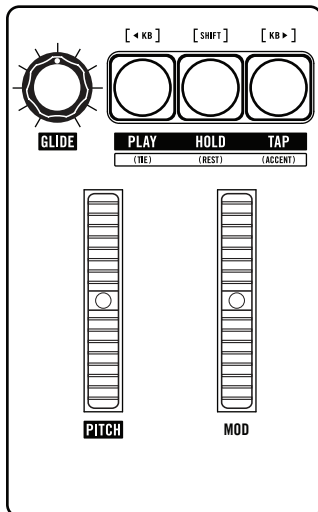

Grandmother's Left-Hand Controller is home to numerous performance and programming controls including **PITCH** and **MOD** wheels, a **GLIDE** control, and transport controls for the Arpeggiator and Sequencer.

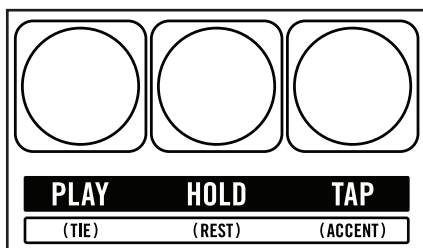

ARP / SEQUENCER CONTROLS

The **PLAY**, **HOLD**, and **TAP** buttons provide access to, and control over, the **ARP / SEQ** module. When recording a sequence, their function changes and they become the **(TIE)**, **(REST)**, and **(ACCENT)** buttons. To learn more about the Arpeggiator and Sequencer, go to page 27.

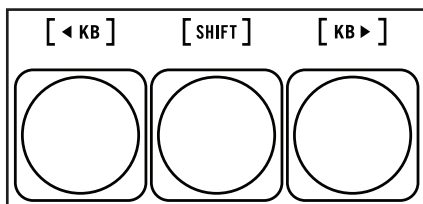

OCTAVE TRANSPOSE

Grandmother is designed to behave and function like a traditional analog instrument, but changing keyboard octaves is a useful function for live performance and interfacing with other MIDI equipped devices. To transpose the keyboard by octave units, simply press and hold the **[SHIFT]** button, and then press the **[<KB]** button (down one octave) or **[KB>]** button (up one octave).

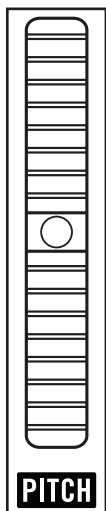

PITCH

The **PITCH** wheel provides an intuitive method for quickly bending the pitch of the Oscillators up or down during live performance.

NOTE: The **PITCH** wheel is spring-loaded and will return to center position as soon as it is released.

LEFT HAND CONTROLLER *(Continued)*

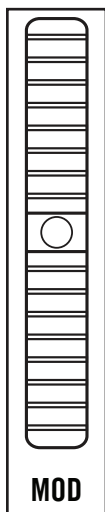

MOD

The **MOD** wheel determines how much modulation is applied to the Filter Cutoff frequency, the pitch of the Oscillators, and to the width of the Pulse waveforms. It scales the overall amount of modulation from Off to the maximum settings specified by the **PITCH AMT**, **CUTOFF AMT**, and **PULSE WIDTH AMT** knobs in the **MODULATION** section.

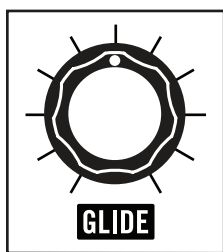

GLIDE

Glide produces a smooth, continuous change in pitch between notes when transitioning from one note to the next. The **GLIDE** knob sets the amount of time needed to complete this transition. When the **GLIDE** knob is set to minimum, there is no Glide effect. Raising the value of the **GLIDE** knob will increase the Glide time between notes.

***TIP:** Legato glide is useful when creating acid-style sequences. To turn Legato Glide On, continue to press the **HOLD** button while turning the **GLIDE** knob to the right. To turn Legato Glide Off, continue to press the **HOLD** button while turning the **GLIDE** knob to the left. The Default is Off.*

■ OSCILLATORS

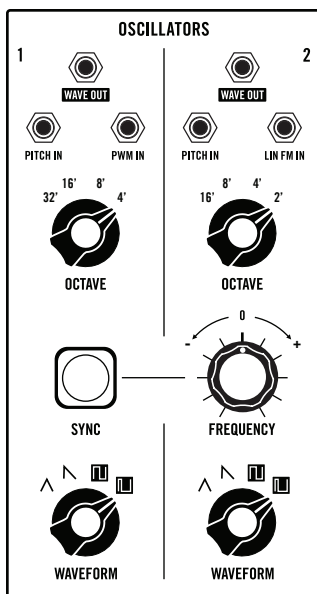

This is where the sound of the synthesizer is born. Grandmother provides two oscillators of almost identical design, each with its own Octave and Waveform settings. Oscillator 2 is equipped with a **FREQUENCY** knob to detune it from Oscillator 1.

***NOTE:** There is a **FINE TUNE** knob located on the rear panel for adjusting the overall tuning of the instrument.*

OSCILLATORS *(Continued)*

OSCILLATOR 1

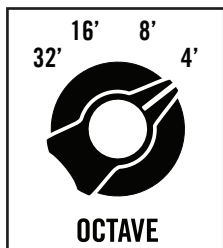

OCTAVE

This four-position switch is used to select the fundamental Octave setting for Oscillator 1. The choices are 32', 16', 8', and 4'.

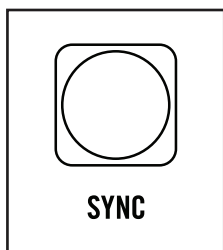

SYNC

When this button is lit, the phase of Oscillator 2 is hard Sync'd to the phase of Oscillator 1. This will cause Oscillator 2 to reset at each zero-crossing of Oscillator 1. This forced synchronization causes the waveform of Oscillator 2 to take on a more complex wave shape as it works to stay aligned with Oscillator 1. Sync is useful for creating sharp, metallic, and flange-like sounds, while also ensuring that the pitch of Oscillator 2 stays locked to Oscillator 1.

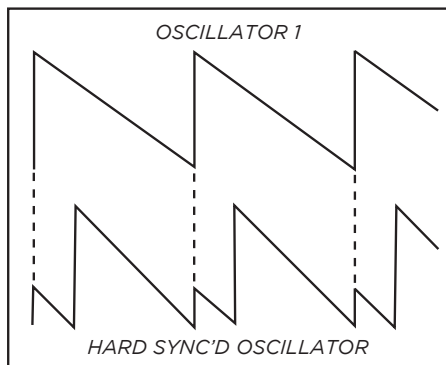

TIP: Applying modulation to the Frequency of Oscillator 2 is a great way to enhance the Sync effect.

NOTE: When Sync is on and the Frequency of Oscillator 2 is set higher than that of Oscillator 1, Oscillator 2 will not be able to complete a full cycle before it is forced to reset, resulting in little or no output.



WAVEFORM

This four-position knob is used to select the Waveform setting for Oscillator 1. The choices are Triangle, Saw, Square, and Narrow Pulse.

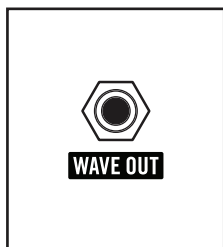

WAVE OUT

The audio signal coming from this output is determined by the settings of the Oscillator 1 **OCTAVE** and **WAVEFORM** knobs.

OSCILLATOR 1 (Continued)



PITCH IN

A control signal connected to this input will modulate the Pitch (Frequency) of Oscillator 1. This input voltage is added to the voltage from the note played on the keyboard.

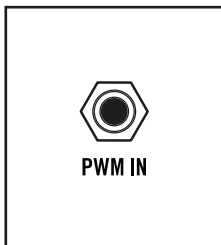

PWM IN

A control signal connected to this input will modulate the pulse width of the Square or Narrow Pulse waveform selected by Oscillator 1. Pulse Width Modulation (PWM) varies the duty cycle, or pulse width of a wave, and thereby changes its harmonic content. Among other things, PWM is often used to mimic the sound of ensembled strings and to thicken bass sounds.

OSCILLATOR 2

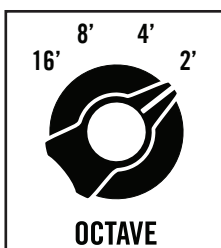

OCTAVE

This four-position switch is used to select the fundamental Octave setting for Oscillator 2. The choices are 16', 8', 4', and 2'.

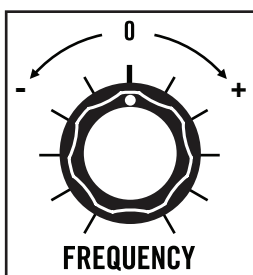

FREQUENCY

This knob detunes Oscillator 2 from Oscillator 1 over a range of +/- 7 semi-tones. The center position (12 O'clock) puts Oscillator 2 in unison with Oscillator 1. Increasing the value raises the pitch, decreasing the value lowers the pitch. When the **SYNC** button is lit, the pitch of Oscillator 2 is locked to Oscillator 1; in this case, changing the Frequency value will vary the degree of the Sync effect and effect harmonics. The range of the **FREQUENCY** knob is also greatly increased.

NOTE: The range of the **FREQUENCY** knob can be specified in the Global Settings.



WAVEFORM

This four-position knob is used to select the Waveform setting for Oscillator 2. The choices are Triangle, Saw, Square, and Narrow Pulse.

OSCILLATOR 2 *(Continued)*

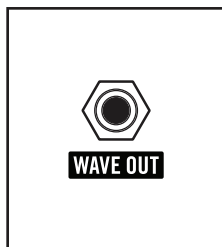

WAVE OUT

The audio signal coming from this output is determined by the settings of the Oscillator 2 **OCTAVE**, **FREQUENCY**, and **WAVEFORM** knobs, as well as the state of the **SYNC** button.

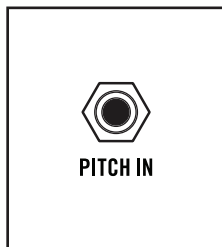

PITCH IN

A control signal connected to this input will modulate the Pitch (Frequency) of Oscillator 2. This input voltage is added to the voltage from the note played on the keyboard.



LIN FM IN

Connecting an audio signal or high-frequency control signal to this input introduces Linear Frequency Modulation (FM) to Oscillator 2, which can be used to create brash, metallic, or bell-like tones.

WAVEFORMS

Each waveform has unique harmonic content that is based on the number and strength of the harmonic overtones that it contains. These overtones are what impart a particular timbre, or character, to the sound of an Oscillator.

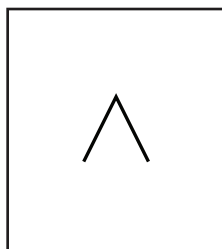

TRIANGLE

The Triangle wave has an extremely strong fundamental, yet contains only odd-numbered harmonics at very low levels. This makes the Triangle wave an ideal choice for creating soft, flute-like sounds that have a pure tone with little overtone activity.

***TIP:** Try mixing a triangle wave from one oscillator with a more complex wave from another to emphasize one particular harmonic without adding unwanted overtones.*

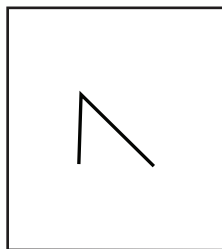

SAWTOOTH

The Sawtooth wave is the most harmonically dense of the four waveform options, containing all of the natural harmonics in relatively strong levels. In addition to creating thick, brassy sounds, the Sawtooth wave lends itself to powerful lead, brass, and bass sounds as well.

WAVEFORMS (Continued)

PULSE WAVES (SQUARE & NARROW PULSE)

A pulse wave contains only odd-numbered harmonics. Think of it as a switch you can turn off and on hundreds of times per second. Pulse width, or duty cycle, is the percentage of time that the wave is “on”. Every pulse width has its own unique harmonic structure, making a variety of basic timbres possible.

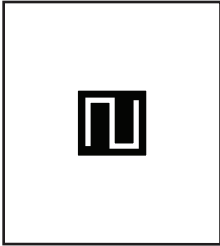

SQUARE

A Square wave is simply a pulse wave with 50% duty cycle, meaning that in a single cycle, it is on half the time and off half the time. If its frequency is 440Hz, that means it goes on and off 440 times every second. Square waves sound hollow and provide a rich starting point for oboe and bass sounds.

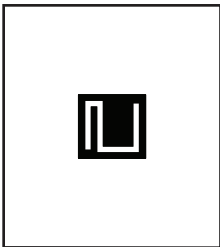

NARROW PULSE

As a pulse wave continues to get narrower, lower numbered harmonics—both odd and even—are emphasized. The resulting timbre takes on a more reedy, or nasal tone.

TIP: Varying the duty cycle of the Pulse wave can result in a wide variety of lush or chorus-like sounds. With at least one Pulse wave selected, try experimenting with the **PULSE WIDTH AMT** knob in the Modulation section and listen to how modulating this waveform affects the sound.

MIXER

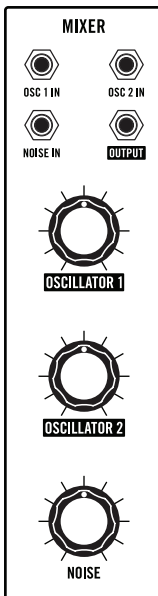

The Mixer is where all of the sound sources within Grandmother are blended together before being passed on to the Filter. Patch points in the Mixer allow each hardwired source (Oscillator 1, Oscillator 2, Noise) to be replaced with an external audio signal.

NOTE: The **MIXER** is DC coupled, which means it can be used to sum multiple control voltages. Combining audio signals and control signals will yield results that may or may not be desirable.



OSCILLATOR 1

The **OSCILLATOR 1** knob sets the level of Oscillator 1 as it enters the mixer. Settings above 1 O'clock will begin to impart gentle distortion, while higher settings will result in more overdriven tones.

MIXER (Continued)



OSCILLATOR 2

The **OSCILLATOR 2** knob sets the level of Oscillator 2 as it enters the mixer. Settings above 1 O'clock will begin to impart gentle distortion, while higher settings will result in more overdriven tones.

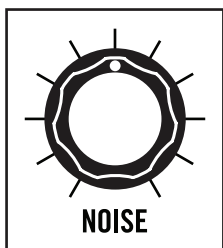

NOISE

The **NOISE** knob sets the level of Grandmother's white noise generator as it enters the mixer. Settings above 1 O'clock will begin to impart gentle distortion, while higher settings will result in more overdriven tones. Noise is an un-pitched sound source that can be a useful tool for creating explosive percussion sounds, or for adding a gentle breath to the synthesized wind instruments like flutes.



OSC 1 IN

When an external sound source is patched to this input, Oscillator 1 will be removed from the signal path, and the **OSCILLATOR 1** knob will control the level of the new source.



OSC 2 IN

When an external sound source is patched to this input, Oscillator 2 will be removed from the signal path, and the **OSCILLATOR 2** knob will control the level of the new source.

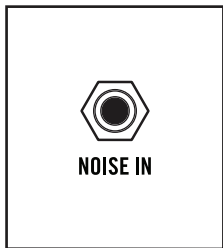

NOISE IN

When an external sound source is patched to this input, the Noise generator will be removed from the signal path, and the **NOISE** knob will control the level of the new source.

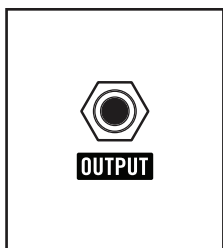

OUTPUT

The combined signal of all sources connected to the mixer is available at this output.

TIP: Try patching from the **MIXER OUTPUT** to the **INPUT** of the High Pass Filter in the Utilities section. Then patch from the **OUTPUT** of the High Pass to the **INPUT** of the Low Pass Filter. Now you have two filters for sculpting sounds.

FILTER

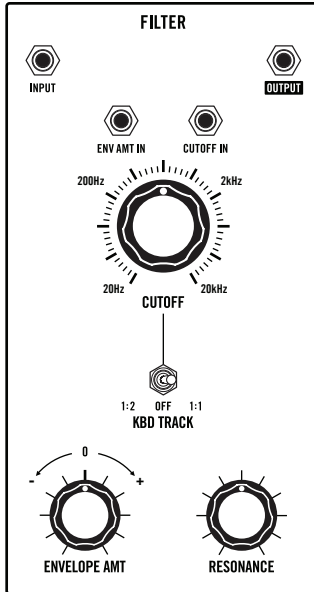

Grandmother relies on a classic -24dB/octave Moog Low Pass Ladder Filter. The term “Ladder” stems from the hardware design of the original filter, which has transistors wired in a type of ladder configuration. Low Pass indicates that the Filter is selectively removing harmonic content in the upper part of the audio spectrum, while allowing the lower frequencies to pass unaffected - this is the essence of a low pass filter, and the foundation of subtractive analog synthesis. Finally, the -24dB specification indicates how frequencies are attenuated above the Cutoff frequency. In this case, harmonic content is rolled off at a rate of -24dB per octave.

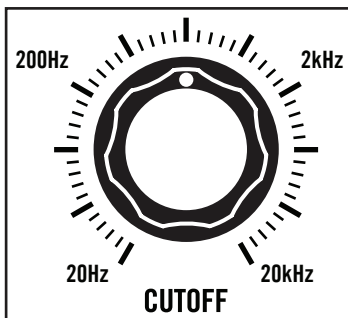

CUTOFF

The **CUTOFF** knob specifies the frequency at which the Filter begins to attenuate (or reduce) harmonic content, from 10Hz to 20kHz. Harmonic content occurring above the Cutoff frequency is attenuated, while sounds occurring below the Cutoff frequency will pass through unaffected. As the Cutoff frequency is lowered, less harmonic content is able to pass, resulting in a progressively darker sound. Raising the Cutoff frequency opens the Filter, and more harmonic content is able to pass, creating a progressively brighter sound.

NOTE: Filter Cutoff is one of the most effective parameters to apply modulation to. Doing so allows the sound to have motion and character, without interfering with the ability to play “tonal” music in the way that applying modulation to the Oscillators’ frequency might.

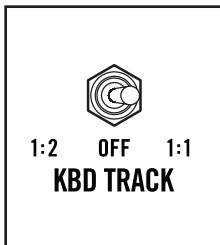

KBD TRACK

Keyboard Tracking allows the value of the note played on the keyboard to also affect the Cutoff frequency of the Filter. Higher notes on the keyboard will be perceived as being brighter than notes played lower on the keyboard. This is how many acoustic instruments sound in nature; higher pitched notes have more upper harmonic energy and appear to be brighter.

1:2

In the **1:2** position, the value of the note played on the keyboard will affect the Cutoff frequency at half of its full value. This means that playing a note two octaves above another will only raise the Cutoff frequency by one octave.

OFF

In the **OFF** position, the keyboard Tracking is off, and the value of the note played on the keyboard will have no effect on the Cutoff frequency.

KBD TRACKING (Continued)

1:1

In the **1:1** position, the value of the note played on the keyboard will affect the Cutoff frequency at full value. This means that playing a note two octaves above another will raise the Cutoff frequency by a full two octaves.

TECH NOTE: The Keyboard Tracking value in the **1:1** selection is 1 Volt-per-Octave.

TIP: Turn the **OSCILLATOR 1** and **2** knobs in the mixer all the way down, and turn the **NOISE** knob half way up. Now, set the **RESONANCE** knob to its middle position and set the **KBD TRACK** switch to **1:1**. This will allow the Filter to be played from the keyboard while also creating an eerie sound.

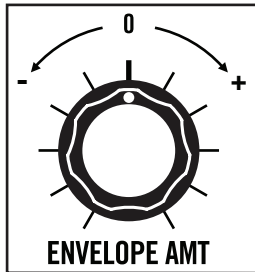

ENVELOPE AMT

The **ENVELOPE AMT** knob determines how much of the control signal created by the Envelope will be applied to the Filter's Cutoff frequency over time. This knob is bipolar, so turning the **ENVELOPE AMT** knob clockwise from center will raise the Filter's Cutoff frequency from the **CUTOFF** knob's current setting. Turning it counterclockwise from center will lower the Filter's Cutoff frequency from the **CUTOFF** knob's current setting.

NOTE: Negative, or inverse, modulation simply flips the shape of the Envelope generator. Instead of the Attack parameter raising the Cutoff frequency over time, the Attack parameter will lower the Cutoff frequency by the same amount, in the same period of time.

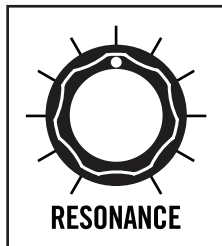

RESONANCE

Resonance takes a portion of the Filter's output and sends it back to the input of the Filter, creating emphasis at the Filter's Cutoff frequency. This is useful for adding focus, articulation, or "frickin' laser beams" to a sound.

NOTE: Adding Resonance may reduce the overall volume or bottom-end of a sound. This is normal.

TIP: Turn the **RESONANCE** knob all the way up and lower the **CUTOFF** knob to about 10 O'clock to cause the Filter to self-oscillate. Then set the **KBD TRACK** switch to **1:1** to play the Filter from the keyboard as a Sine wave oscillator.

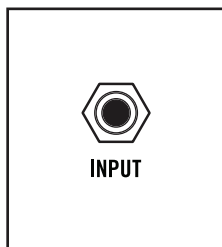

INPUT

An audio signal from an internal or external module can be introduced to the Filter using this input. Any sound source applied to this input will disconnect the normalised Mixer Output signal from the input of the Filter.

NOTE: Do not use this input to introduce an instrument or line-level signal. The high-impedance 1/4" **INSTRUMENT IN** jack on the rear panel is available for these purposes.

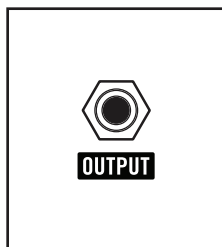

OUTPUT

The audio signal exiting the Filter is available at this output.

TIP: Patching from the Output of the Filter to the Input of the High Pass Filter, and then from the Output of the High Pass Filter to the **VCA IN** in the Output section allows you to vary the low-end "weight" of a sound without affecting the relationship between the Mixer and the Low Pass Filter.

FILTER (Continued)

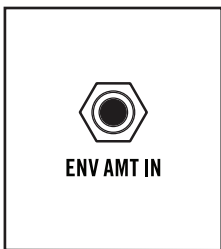

ENV AMT IN

A control signal connected to this input can be used to vary the value of the **ENVELOPE AMT** knob.

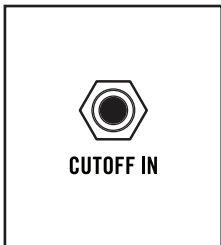

CUTOFF IN

A control signal connected to this input can be used to vary the value of the Filter's Cutoff frequency.

■ ENVELOPE (ADSR)

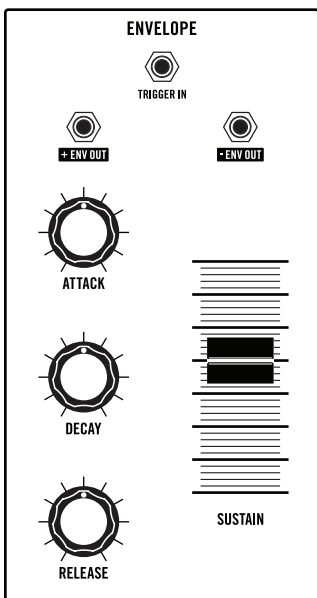

Sounds change over time. How they change over time is part of what makes each one unique. Some sounds begin abruptly, like the strike of a drum. Some sounds end just as quickly, and some linger like a held chord on a piano. We call this the envelope of a sound. Grandmother uses an Envelope generator to create a control voltage that will change over time. This control voltage is then applied to the volume of the sound. This same control voltage can be used to affect the Cutoff frequency of the Filter over time, creating changes in timbre, or tone. Regardless of how the Envelope is applied, there are four main stages: **ATTACK** time, **DECAY** time, **SUSTAIN** level, and **RELEASE** time.

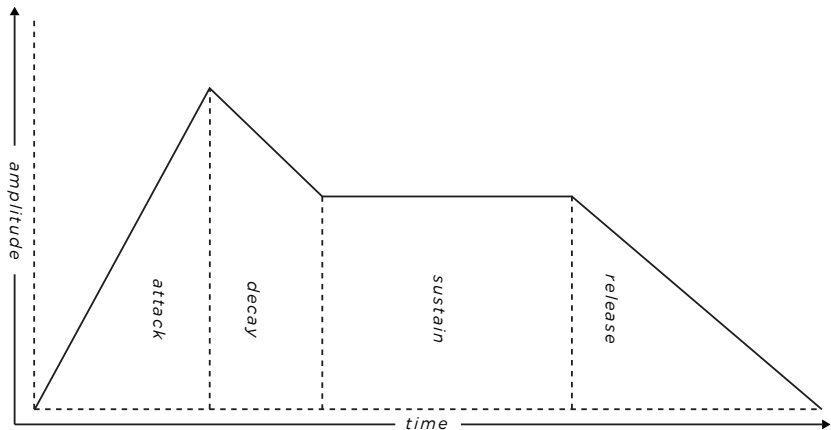

ENVELOPE (ADSR) *(Continued)*

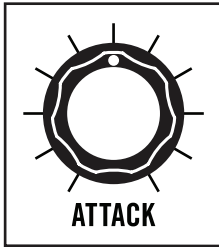

ATTACK

The **ATTACK** knob determines the amount of time required for the control signal to rise from zero to its maximum level once a key is pressed. Fast attacks are useful for creating plucked sounds, while slow attacks are more useful for creating bowed string sounds and swells.

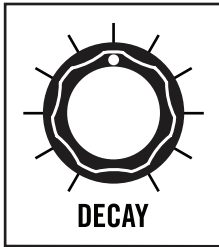

DECAY

The **DECAY** knob determines the amount of time required for the control signal to fall from the maximum level achieved by the Attack stage to the Sustain level when a key is held. Fast decay times are useful for creating articulated lead notes, while longer decay times allow a note to fade slowly into the Sustain level.

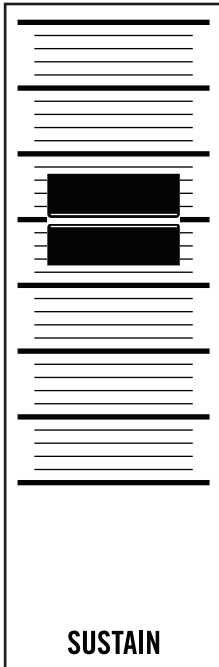

SUSTAIN

While the Attack, Decay, and Release parameters deal with time, the Sustain parameter controls level. Once the Attack and Decay stages are complete, the control signal will remain at the level set by the **SUSTAIN** slider for as long as a key is held.



RELEASE

The **RELEASE** knob determines the amount of time required for the control signal to fall from its Sustain level to zero once a key is released. Shorter settings are good for classic funk basses that end abruptly, while longer settings are good for creating smooth musical tails that ring out over time.

ENVELOPE (ADSR) (Continued)

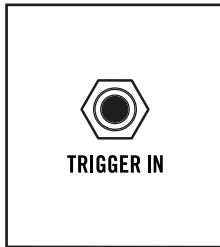

TRIGGER IN

A gate or trigger signal applied here will cause the Envelope to re-trigger and advance through the ADSR stages as defined by their respective settings.

TECH NOTE: Any signal > 1.2 Volts will be read as a trigger.

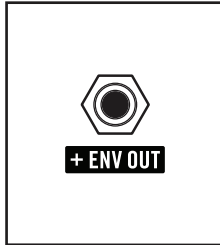

+ ENV OUT

A control signal that reflects the shape created by the current Envelope generator settings is available at this output.

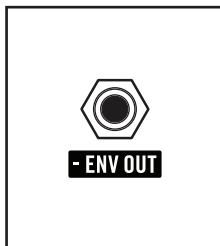

- ENV OUT

The control signal available via this output is an inverted copy of the signal created by the Envelope. Instead of the Attack parameter raising a particular value over time, inverse modulation values cause the Attack parameter to lower a particular value by the same amount, in the same period of time.

■ OUTPUT

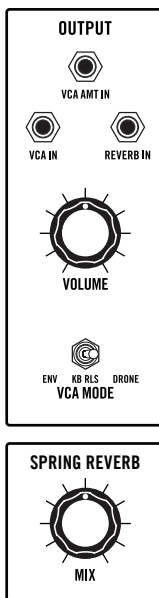

The Output module is home to parameters that determine how the final sound is heard. These include the output **VOLUME** knob, **VCA** (Voltage Controlled Amplifier) **MODE** switch, and the **SPRING REVERB MIX** knob.

OUTPUT (Continued)

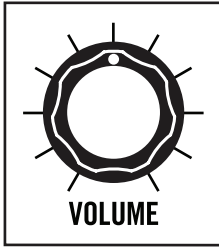

VOLUME

The **VOLUME** knob sets the level for the combined **MAIN OUT / HEADPHONE OUT** 1/4" jack located on the rear panel.

NOTE: The **VOLUME** knob is placed after the **SPRING REVERB MIX** knob in the signal path.

NOTE: The level of the **EURORACK** output jack on the rear panel is unaffected by the **VOLUME** knob setting

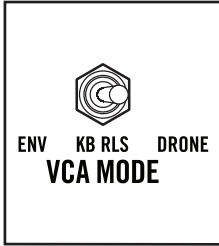

VCA MODE

The Voltage Controlled Amplifier, or VCA, is an amplifier that can be modulated from different sources to control Grandmother's output level. Most often the control source is the Envelope generator – but not always.

ENV (ENVELOPE)

In the **ENV** position, the output Volume will be controlled by the Envelope generator.

KB RLS (KEYBOARD RELEASE)

In the **KB RLS** position, the attack of each note will be instantaneous, and will sound at the maximum sustain level for as long as a note is held. Once the note is released, the VCA will follow the Envelope Release setting to determine how long it takes for the sound to fade from its maximum level to zero. This is particularly useful when paired with exaggerated filter modulation.

NOTE: **KB RLS** was inspired by the classic Moog **KB GATE** function, but has been modified for greater musical flexibility.

DRONE

In the **DRONE** position, Grandmother will continue to output sound at the current volume level whether a key is held or not. This can be valuable when creating synthetic textures and droning sounds, and when processing external audio signals via the **INSTRUMENT IN** jack.

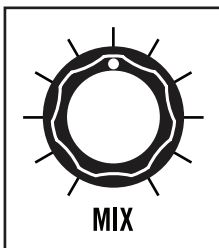

MIX (SPRING REVERB)

The **MIX** knob sets the balance between the dry (unaffected) signal, and the wet (fully affected) sound of the built-in spring reverb tank. At minimum position, no Reverb is present. At maximum position, the dry signal is absent, and only the Reverb signal is present.

NOTE: The **MIX** knob has no effect on the rear panel **REVERB OUTPUT** jack as it is always 100% wet.

CRITICAL NOTE: Grandmother's Spring Reverb may be susceptible to physical vibrations and electro-magnetic interference from other sources - radio signals, cell phones, etc. This is due to the nature and construction of an analog spring reverb tank, and is normal.

OUTPUT *(Continued)*

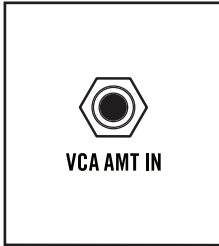

VCA AMT IN

A control signal connected to this input will influence Grandmother's overall output Volume. With the **VCA TYPE** switch set to **DRONE**, an external control signal received here will entirely determine the output Volume. With the **VCA MODE** switch set to **ENV** or **KB RLS**, a control signal received here will be multiplied with the current parameter settings to determine the output Volume, which is useful for synthesizing tremolo effects.

***TIP:** Patching the modulation **WAVE OUT** jack to the **VCA AMT IN** jack can create some interesting AM (Amplitude Modulation) effects.*

***NOTE:** With the **VCA MODE** switch set to **DRONE** and an external CV patched into the **VCA AMT IN** jack, Grandmother's output **VCA** will behave as a standard VCA whose level is set entirely by an external control voltage. A voltage of 0V, or a negative voltage, will result in silence. As the voltage to this input is increased, the output volume will also increase (+8V maximum).*

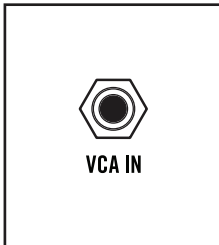

VCA IN

This is an audio input to the VCA. Connecting an alternate audio source to this input disconnects the output of the Filter from the input of the VCA.



REVERB IN

This is an audio input to the Spring Reverb. Connecting an alternate audio source to this input disconnects the output of the VCA from the input of the Spring Reverb.

■ MODULATION

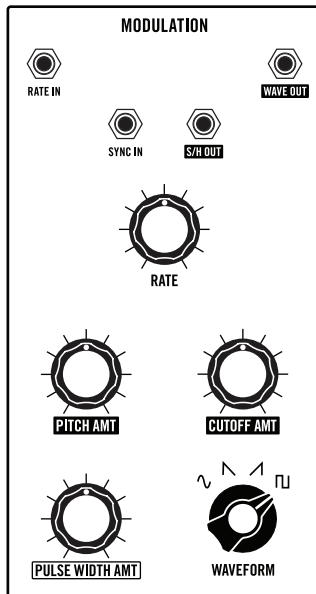

Modulation is an important aspect of programming and playing synthesizers. In short, whenever one signal is used to change the value of another – it is known as modulation. Grandmother has a dedicated Modulation section that can apply modulation to multiple destinations at once, and in varying amounts. This Modulation section is based around an analog oscillator that operates in the low-frequency range, and is commonly known as an LFO (Low Frequency Oscillator).

NOTE: The **PITCH AMT**, **CUTOFF AMT**, and **PULSE WIDTH AMT** knobs are used to specify the maximum amount of modulation to be applied to specific parameters. In order to actually apply the modulation and hear the effect, the **MOD** wheel must be set to a greater than minimum position.

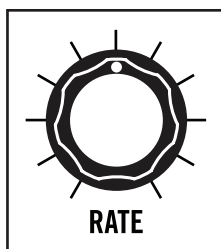

RATE

The **RATE** knob sets the frequency of the LFO from .07 Hz to 1.3 kHz. The accompanying LED will flash at the current Rate setting.

TIP: Patching from the **KB OUT** in the **ARP / SEQ** section, into the **RATE IN** jack will cause the LFO to track the pitch of the keyboard just as Oscillator 1 and 2. This will also allow the LFO to exceed the range of the panel **RATE** control.

TIP: Holding the **SHIFT** button while adjusting the Modulation **RATE** knob allows fine-tuning of the LFO rate, which is useful when utilizing the Modulation LFO as an audio oscillator.

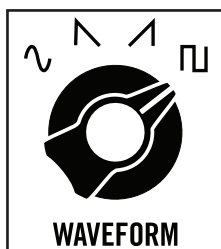

WAVEFORM

This four-position knob is used to select the Waveform for the Modulation LFO. The choices are Sine, Sawtooth, Ramp, and Square.

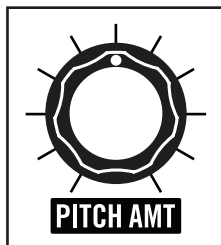

PITCH AMT (AMOUNT)

The **PITCH AMT** knob determines the maximum depth of modulation that will be applied to the Pitch of Oscillators 1 and 2 when the **MOD** wheel is at its maximum position.

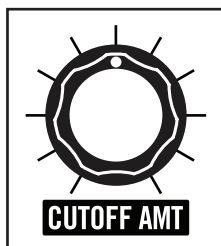

CUTOFF AMT (AMOUNT)

The **CUTOFF AMT** knob determines the maximum depth of modulation that will be applied to the Cutoff frequency of the Low Pass Filter when the **MOD** wheel is at its maximum position.

MODULATION (Continued)

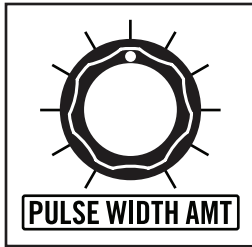

PULSE WIDTH AMT (AMOUNT)

The **PULSE WIDTH AMT** knob determines the maximum depth of modulation that will be applied to the Pulse Width of the Square and Narrow Pulse waves of Oscillators 1 and 2 when the **MOD** wheel is at its maximum position.

NOTE: Pulse Width Modulation (PWM) can only be applied to an oscillator when a square or narrow pulse wave is selected as the current waveform. Pulse Width Modulation continuously varies the duty cycle, or pulse width, of these waves, causing the harmonic content to continuously vary as well.



RATE IN

A control signal received here is added to the value of the **RATE** knob to determine the frequency of the LFO.

TECH TIP: The **RATE IN** patch point is based on the 1 Volt-per-Octave standard, allowing the LFO to be “played” like an oscillator.

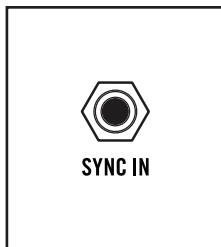

SYNC IN

A gate or trigger pulse received here will reset the LFO wave to its starting point.

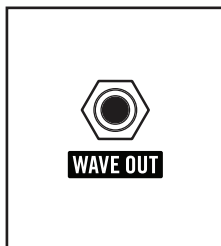

WAVE OUT

The control signal available at this output is determined by the **WAVEFORM** and **RATE** knob settings.



S/H OUT

Sample/Hold (S/H) is a stepped modulation effect, often used to “pulse” the Cutoff frequency of a Low Pass filter with near random values. At the beginning of every modulation wave cycle, the Noise generator is sampled to acquire a control value that can be used to modulate another parameter. That stream of Sample/Hold values is available via this output.

TIP: A control or gate signal received at the **SYNC IN** jack will reset the Modulation generator to the beginning of its wave cycle, meaning the Sample & Hold feature can be stepped by an external trigger or gate. Try patching from the **GATE OUT** in the **ARP / SEQ** section to the **SYNC IN**, and set the **RATE** control to its minimum value. This will allow you to use the keyboard to step through Sample & Hold values with each key press.

NOTE: There is no internal routing to use the Sample/Hold generator, so it must be patched from this jack to a specific destination in order for it to modulate another parameter.

UTILITIES

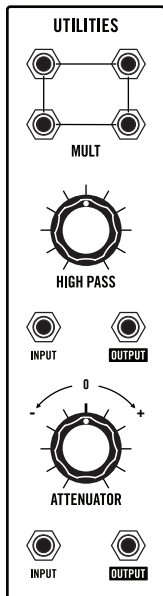

The Utilities section imbues Grandmother with a series of tools that are key to the exploration of modular analog synthesis. A four-point mult, high pass filter, and bipolar attenuator are included as non-wired, patchable resources.

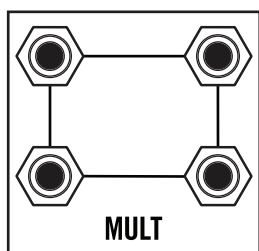

MULT

The **MULT** consists of four jacks wired together in parallel as a way of sharing and distributing control signals. For example, the **S/H OUT** of the **MODULATION** generator could be connected to the **MULT**, where it could then be sent to three different locations. The **MULT** jacks can also be used to safely mix two audio signals together so that the combined audio signal can then be sent to a single audio input.

NOTE: Only audio signals may be merged using the **MULT** jacks, and only audio signals that are AC coupled. These signals include **OSCILLATOR 1 WAVE OUT**, **OSCILLATOR 2 WAVE OUT**, **FILTER OUT**, **HIGH PASS FILTER OUT**, **REVERB OUT**, and **EURORACK OUT**.

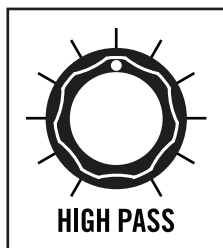

HIGH PASS FILTER

Grandmother contains two independent filters: a Voltage Controlled Low Pass Filter, and this static -6dB/Octave High Pass Filter. Unlike the Low Pass Filter, the High Pass Filter must be patched to become part of the audio path - but there are many possibilities. The **HIGH PASS** knob sets the Cutoff frequency of the High Pass Filter. Frequencies and harmonic content above the **HIGH PASS** knob setting are free to pass, while frequencies below the **HIGH PASS** knob setting will be diminished at a rate of 6dB per octave.

TIP: Try patching the **WAVE OUT** of Oscillator 2, into the **INPUT** of the High Pass Filter. Then patch the **OUTPUT** of the High Pass Filter into the **OSC 2 IN** jack of the Mixer. Now the tone of Oscillator 2 can be shaped independently of Oscillator 1.

ADVANCED TIP: Patch the output of Oscillator 2 into the High Pass Filter, and then patch the output of the High Pass Filter into one of the **MULT** jacks. Next, patch the output of the Low Pass Filter into another one of the **MULT** jacks. The two audio signals are now merged using the Mult. From here, patch out of a third **MULT** jack into the **VCA IN** jack in the Output section. You are now independently processing each oscillator through its own filter.

UTILITIES (Continued)

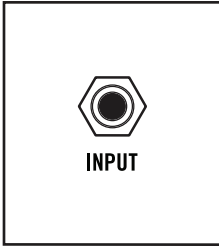

INPUT

An audio signal connected here will be processed by the High Pass Filter.

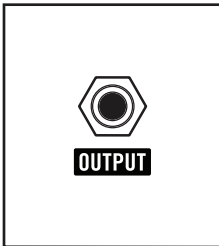

OUTPUT

The audio signal available here is the output of the High Pass Filter.

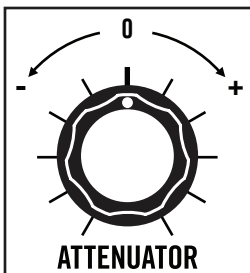

ATTENUATOR (BIPOLAR)

An Attenuator is used to reduce the strength of a control signal to provide more accuracy when modulating a specific parameter value. This Attenuator can also deliver both normal and inverted values. In the center position, the **ATTENUATOR** knob provides its full effect, and any input signal is fully attenuated. Raising the value clockwise from center will provide less and less attenuation, until the full scale of the input signal is restored and passed through unaffected. Lowering the value counterclockwise from center will provide less and less attenuation of the inverted signal, until the full value of the inverted signal is restored at the full counterclockwise position.

NOTE: Negative (or inverse) modulation simply flips the control signal, so that any control signal previously raising the value of a parameter would now be lowering it.

TIP: The input to the attenuator is normalised to a positive voltage. With nothing patched to its input, the output is a DC source of $\pm 8V$. Try patching from the Attenuator **OUTPUT** jack to the **RATE IN** jack of the Modulation section. You can now use the **ATTENUATOR** knob to add to, or subtract from, the minimum or maximum panel values of the Modulation **RATE** knob.

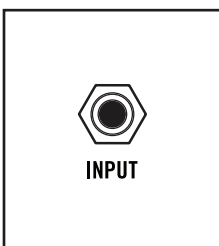

INPUT

Any signal connected here will be processed by the Attenuator.

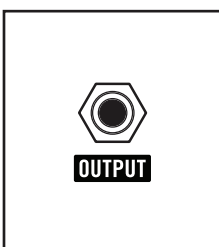

OUTPUT

The signal available here is the output of the Attenuator.

■ ARP / SEQ

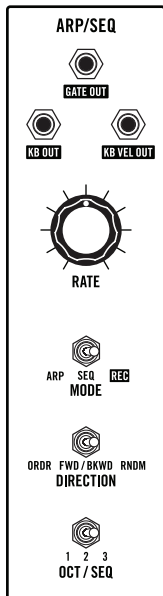

This module contains two very important features: the Arpeggiator and the Sequencer. In addition to the controls found here, the **PLAY**, **HOLD**, and **TAP** buttons located on the Left-Hand Controller are active in operating the Arpeggiator and the Sequencer. This module also contains patch points for **KB OUT** (Keyboard Pitch Control Voltage), **GATE OUT**, and **KB VEL OUT** (Keyboard Velocity Control Voltage).

ARPEGGIATOR

The Arpeggiator takes the notes being held on the keyboard, and plays them one at a time in a repeating, rhythmic pattern. This is useful for creating swooping cascades of notes, building a rhythmic base, or for generating new and fun musical ideas. Grandmother allows you to select the order in which the notes are played, and also provides the option of repeating the pattern in different octaves.

SEQUENCER

The Sequencer is a step sequencer that can store up to 256 steps per sequence. Each step can be entered as a Note or a Rest, and individual steps can also be entered with a Tie and/or an Accent. Three separate sequences can be stored and called up during performance.

NOTE: Sequence memory is retained even with the power off, so sequences can be programmed in advance and used later in performance.

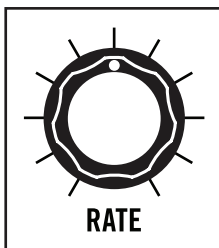

RATE

The **RATE** knob sets the playback speed of the Arpeggiator and the Sequencer, with a tempo range of 20 – 280 BPM (Beats Per Minute). The accompanying LED flashes at the current Rate setting. If Grandmother is synced to MIDI, External Clock, or Tap Tempo, then the **RATE** knob selects timing values that are musical subdivisions of this external tempo.

TIP: The Rate can also be set by pressing the **TAP** button, at the desired tempo, at least three times in a row. To exit Tap Tempo, press and hold the **TAP** button

for about one second, until its light turns off.

NOTE: When synced, turning the **RATE** knob selects even and dotted note values; pressing the **SHIFT** button while turning the **RATE** knob selects triplet note values.

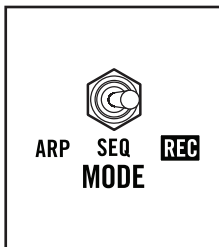

MODE

The **MODE** switch allows you to select between the Arpeggiator and the Sequencer. A third position places the Sequencer into Record mode.

ARP

With the **MODE** switch in the **ARP** position, pressing the **PLAY** button will activate the Arpeggiator.

SEQ

With the **MODE** switch in the **SEQ** position, pressing the **PLAY** button will activate the Sequencer.

REC

With the **MODE** switch in the **REC** position, the Sequencer is armed for recording. From here, entering a new note will overwrite any existing sequencer data for the currently selected sequence (**1**, **2**, or **3**). If the **MODE** switch is set to **REC** while the sequencer is currently playing back an active sequence, individual notes in that sequence can be updated in real time.

ARP / SEQ (Continued)

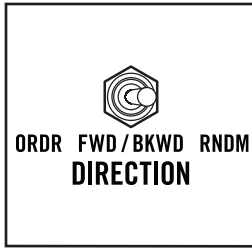

DIRECTION

The function of this switch applies to both the Arpeggiator and the Sequencer. It selects the order in which the notes are played.

ORDR (ORDER) ARPEGGIATOR (ORDR)

The arpeggiated notes will play in the same order as they were originally played on the keyboard.

SEQUENCER (ORDR)

The Sequencer will play notes from the beginning of the pattern to the end.

FWD / BKWD (FORWARD/BACKWARD) ARPEGGIATOR (FWD / BKWD)

The arpeggiated notes will first play in the same order as they were originally played, and then in the inverse of that order.

SEQUENCER (FWD / BKWD)

The Sequencer will play the notes from the beginning of the pattern to the end, and then from the end of the pattern back to the beginning.

RNDM (RANDOM) ARPEGGIATOR (RANDOM)

The arpeggiated notes will play back in a completely random order.

SEQUENCER (RANDOM)

Notes contained in the Sequencer pattern will be played in a random order.



OCT / SEQ

With the **MODE** switch set to the **ARP** position, the **OCT / SEQ** switch specifies the number of octaves that will be used to play the arpeggiated pattern. If the **MODE** switch is set to the **SEQ** or **REC** position, this switch specifies which of the three Sequencer files is being played or recorded.

1 ARPEGGIATOR (1)

Only the notes played are arpeggiated.

SEQUENCER (1)

Sequence 1 is active.

2 ARPEGGIATOR (2)

The arpeggiated pattern is played and then repeated one octave higher than the original.

SEQUENCER (2)

Sequence 2 is active.

3 ARPEGGIATOR (3)

The arpeggiated pattern is played and then repeated one, and then two octaves higher than the original.

SEQUENCER (3)

Sequence 3 is active.

ARP / SEQ (Continued)



GATE OUT

Pressing a note on the keyboard initiates a gate signal that is sent via this jack for as long as the note is held. During arpeggiator or sequencer playback, the **GATE OUT** signal is instead based on the notes being output by the arpeggiator or sequencer.

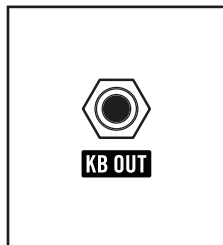

KB OUT

Pressing a note on the keyboard initiates a keyboard control voltage (CV) signal that is based on the note being played, using the 1 Volt-per-Octave standard. During arpeggiator or sequencer playback, the **KB OUT** signal is instead based on the notes being output by the arpeggiator or sequencer.

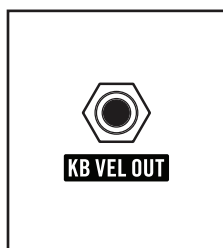

KB VEL OUT

The velocity with which a note is played on the keyboard initiates a keyboard velocity control voltage (CV) signal. This applies to the Keyboard and Arpeggiator only. When the Sequencer is in use, the **KB VEL OUT** jack outputs an accent envelope with a fast attack and release time that can be patched anywhere on the instrument.

■ LEFT HAND CONTROLLER

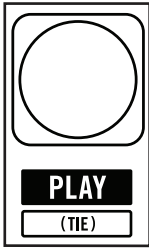

PLAY

The **PLAY** button activates the Arpeggiator or Sequencer.

(TIE)

When the **MODE** switch is set to **REC**, the **PLAY** button is used to enter a **TIE** step when recording to the Sequencer. A tie is used to string two individual notes together musically.

NOTE: *If the same note is tied together multiple times in a row, it will be heard during playback as if that one note is being held continuously. If different notes are tied together, the transition between notes will be heard as legato-style playing. This is especially useful when using Glide.*

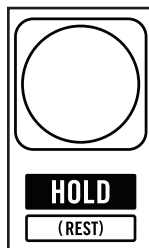

HOLD

The **HOLD** button activates the **HOLD** function, allowing the Arpeggiator or sequencer to continue to play even after your hand is lifted from the keyboard. Notes played while other notes are being held on the keyboard will be added to an arpeggiated pattern. Notes played after all fingers have been lifted from the keyboard will begin a new pattern.

(REST)

When the **MODE** switch set to **REC**, the **HOLD** button is used to enter a **REST** step when recording to the Sequencer. A rest is used to create a timed musical pause.

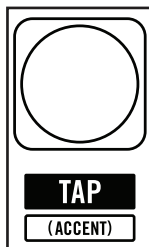

TAP

The **TAP** button can be used to set the Arpeggiator or Sequencer playback rate by feel. Press the **TAP** button at least three times in a row, at the desired tempo, to set the rate of the Arpeggiator or Sequencer. The **TAP** button will light up when Tap Tempo is active. To exit Tap Tempo, press and hold the **TAP** button for about one second, until its light turns off.

NOTE: *If an external clock is detected and in use, the tap-tempo operation will have no effect.*

(ACCENT)

When the **MODE** switch set to **REC**, the **TAP** button is used to add an **ACCENT** to a step when recording to the Sequencer. The Accent function utilizes a dedicated envelope with a fast attack and release time to add musical emphasis or impact to an individual note. This Accent envelope appears at the **KB VEL OUT** jack (**ARP/SEQ** module) when the Sequencer is playing only.

NOTE: *In order to for Grandmother to reflect this dynamic change, you will need to connect a patch cable from the **KB VEL OUT** jack (**ARP / SEQ** module) to the **CUTOFF IN** jack on the Filter module. You can also patch this to other modules for more creative use.*

■ SEQUENCER - GETTING STARTED

Grandmother's sequencer can store and play back three independent sequences, each containing up to 256 notes.

CREATE A SEQUENCE

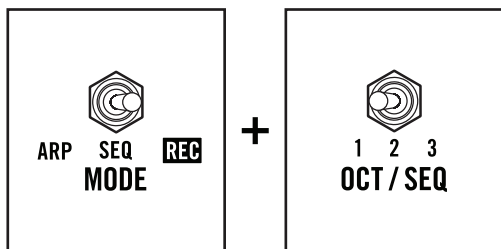

ARM THE SEQUENCER

To arm the Sequencer for recording, set the **MODE** switch to the **REC** position, and set the **OCT / SEQ** switch to **1**.

NOTE: This will arm Sequence 1.



PLAY A NOTE

Play any note on the keyboard. This is the first note of your sequence.

CAUTION: The first note entered in **REC** mode will erase all existing data in a currently selected sequence.

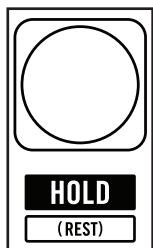

ADD A REST

Press the **REST** button.

NOTE: During playback, this step will be silent.

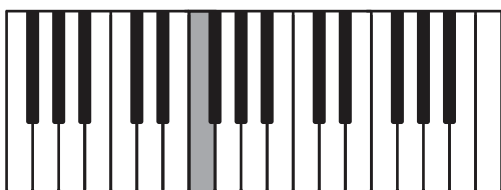

ADD A NOTE

Play another note on the keyboard.

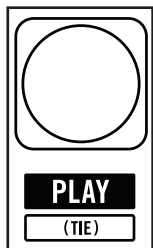

+

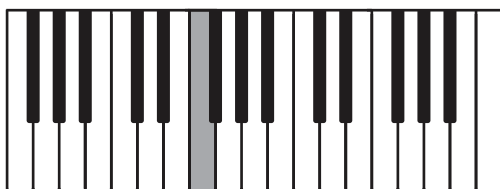

ADD A TIE

Now, press the **TIE** button and then play the same note again.

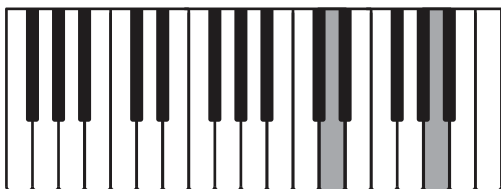

ADD LEGATO

Press and hold a new note. While holding that note, press another note.

NOTE: During playback, the transition between these two notes will have a legato feel.

CREATE A SEQUENCE (Continued)

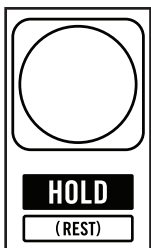

ADD A REST

Press the **REST** button.

NOTE: During playback, this step will be silent.



+

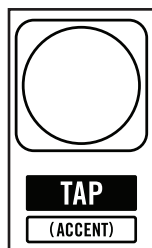

ADD AN ACCENT

Finally, play one last note and then press the **ACCENT** button.

NOTE: During playback, this step will output an Accent voltage from the **KB VEL OUT** jack that can be patched into other modules. A good place to try would be into the **CUTOFF IN** jack in the Filter section.



END RECORDING

To end recording, set the **MODE** switch to the **SEQ** position.

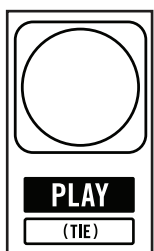

+

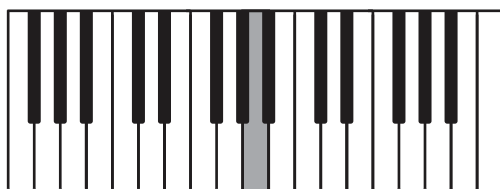

PLAY YOUR SEQUENCE

Now press the **PLAY** button and then press a note to listen to your sequence.

NOTE: You may transpose your sequence by playing a new note.

TIP: Use the **RATE** knob to adjust the playback speed.

DO YOU LIKE YOUR SEQUENCE?

NO!

To delete your sequence, simply start over at the beginning of this tutorial.

YES!

To keep your sequence and create another one, follow the above directions, but be sure to set the **OCT / SEQ** switch to **2** or **3**. (There are three available sequence locations.)

EDITING A SEQUENCE

Sequences can only be edited in real time during live playback. To edit a sequence:

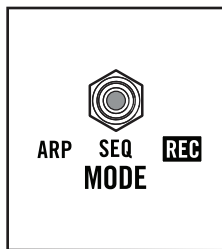

+

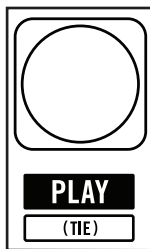

ENTER SEQUENCE EDIT MODE

Set the **MODE** switch to the **SEQ** position and push **PLAY**.

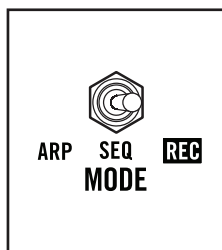

EDIT YOUR SEQUENCE

While your sequence is playing back, set the **MODE** switch to the **REC** position.

NOTE: Now any rest, tie, accent, or note that is played will overwrite the current data for that step as it is played, without deleting the other notes of the sequence.

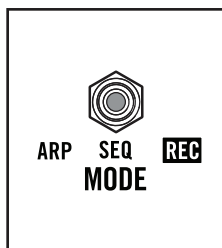

EXIT EDIT MODE

To exit recording, set the **MODE** switch to the **SEQ** position. (The sequence will continue to play, but you are no longer able to edit individual note data.)

WARNING: The sequencer must be playing in order to edit note data in real time. If the **MODE** switch is set to **REC** and a note is pressed while the sequencer is stopped, all data for that sequence will be erased.

SEQUENCING TIP: Legato glide is useful when creating acid-style sequences.

To turn Legato Glide ON, hold the **SHIFT** button and turn the **GLIDE** knob to the right. To turn Legato Glide OFF, hold the **SHIFT** button and turn the **GLIDE** knob to the left. The Default is OFF.

REAR PANEL

Grandmother's rear panel is populated by jacks and connectors that relate to the instrument as a whole. Here is where you will find audio and MIDI connections, additional CV I/O, a **FINE TUNE** knob, the connection for the AC adapter with stress relief hook, and a Kensington security slot.



FINE TUNE

This knob controls the fine tuning of Oscillators 1 & 2, and is the default tuning knob for Oscillator 1.

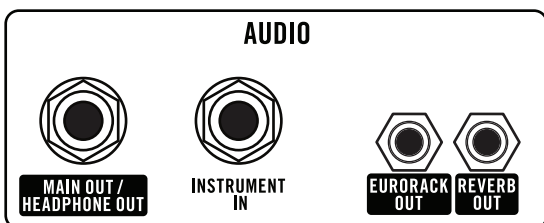

AUDIO

This group of jacks is dedicated to inputting and outputting audio signals.



MAIN OUT / HEADPHONE OUT

This 1/4" TRS output is suitable for both headphone monitoring and connection to an amplifier, PA system, recording equipment, etc.

WARNING: Do not use a TRS (balanced) cable for line output applications as this will cause phase cancellation and a very weak signal. Since the audio output is in mono, it's best to just use a standard 1/4" TS (instrument/guitar) cable.



INSTRUMENT IN

This 1/4" input allows an external sound source to be processed by Grandmother's analog circuits. There is no gain control for this input, so its preamp has been designed to bring low level signals (like that of a guitar) up to 10 Volts (peak-to-peak) in the Mixer. When connected to sources like a cell phone, drum machine, or other synthesizers, this input can easily be pushed into hard, musical clipping.

TIP: Even a high-output guitar signal can clip the mixer in some cases, which may or may not be desirable. Be sure to use the volume knob on your external sound source to dial in the sound you are looking for.



EURORACK OUT

This 3.5mm output duplicates the **MAIN OUT** signal, but at typical Eurorack audio levels (-5 to +5 Volts).

NOTE: The output level of the **EURORACK OUT** jack is not controlled by the **VOLUME** knob in the Output module

REAR PANEL *(Continued)*

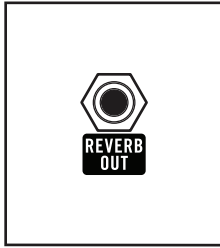

REVERB OUT

This 3.5mm output provides a separate output directly from the Spring Reverb tank at typical Eurorack audio levels. When combined with the **REVERB IN** patch point on the front panel, this jack allows the Spring Reverb to be used as a standalone processor.

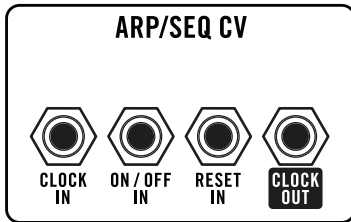

ARP / SEQ CV

This group of jacks is dedicated to synchronizing the Arpeggiator or Sequencer with other analog instruments.

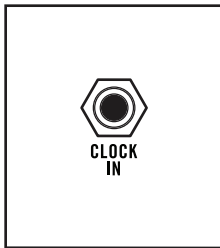

CLOCK IN

This input allows Grandmother to be synchronized to an external clock source such as a DFAM, Mother-32, or any other instrument that outputs clock sync. There are two modes for this jack, Clock or Step-Advance. In Clock Mode, the timing of clock pulses received at the **CLOCK IN** sets the tempo of the Arpeggiator and Sequencer, according to the Clock Input PPQN (Pulses Per Quarter Note), which is set in the Global Settings (see p.38). In Step-Advance mode, the Sequencer or Arpeggiator pattern is advanced by one step each time the rising edge of a gate or pulse signal is detected at the Clock Input.

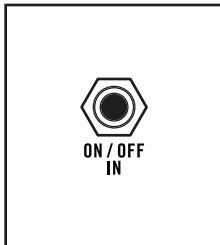

ON / OFF IN

A +5V signal received here will cause the Arpeggiator or Sequencer to Play, while a 0V signal received here will cause the Arpeggiator or Sequencer to stop.

NOTE: Signals with a voltage greater than 2.5 Volts will activate the ARP / SEQ; signals with a voltage less than 2.5 Volts will deactivate the ARP / SEQ.

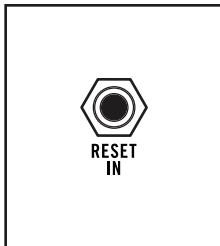

RESET IN

A +5V signal received here will cause the Arpeggiator or Sequencer to reset to the beginning of the pattern or sequence without stopping.

NOTE: The **RESET IN** jack responds to voltages greater than 2.5 Volts.



CLOCK OUT

This output allows Grandmother to transmit clock sync to other instruments based on the **ARP / SEQ RATE** knob setting, and the Global **CLOCK OUTPUT** PPQN setting (see p. 38). Grandmother can also send Clock information via MIDI.

REAR PANEL (Continued)

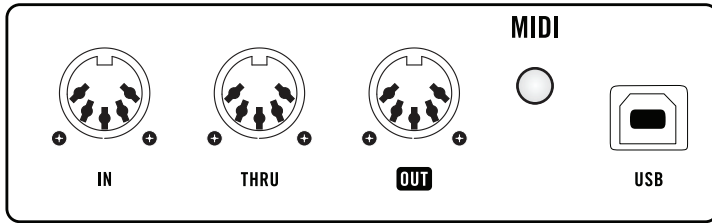

MIDI

These 5-pin DIN style jacks provide a way of sharing MIDI signals with other MIDI-equipped synthesizers, keyboards, processors, and more. MIDI information can also be shared via USB.

TIP: If you get any stuck MIDI notes, hold all three LHC buttons down together for about 1 second. Grandmother will clear its note stack and also send a MIDI "All Notes Off" message.

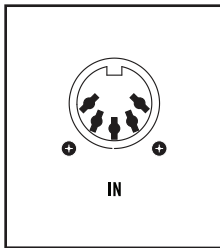

MIDI IN

The **MIDI IN** port can receive MIDI messages sent from another synthesizer or module.

NOTE: The MIDI LED will blink when a MIDI signal is present at this input.

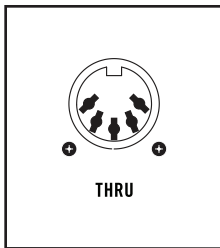

MIDI THRU

The MIDI signal received at the **MIDI IN** port is passed along unchanged via this port.

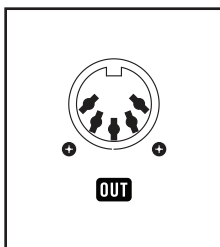

MIDI OUT

MIDI signals created and originating with Grandmother can be shared with other MIDI compatible equipment via this port.

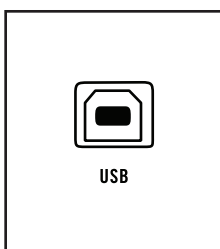

MIDI USB

MIDI signals may be sent and received via USB, allowing Grandmother to integrate with computer-based DAW systems, etc.

GLOBAL SETTINGS

To access Grandmother's Global Settings, simultaneously press and hold the **HOLD** button (on the Left-Hand Controller) and **SYNC** button (in Oscillator 1) until the **SYNC** button begins to blink. Now you can use the keyboard commands listed below to make any needed changes to the Global Settings. The **SYNC** button will continue to blink a number of times to indicate which Global Setting is currently selected. When you have finished making any changes, simply press the **SYNC** button to exit the Global Settings edit mode.

TIP: You can also double-tap your Global Settings selection on a white key to update a setting and exit the edit mode.

NOTE: Global Settings are retained even when the power has been turned off.

For information on advanced Global Settings visit www.moogmusic.com/grandmother.

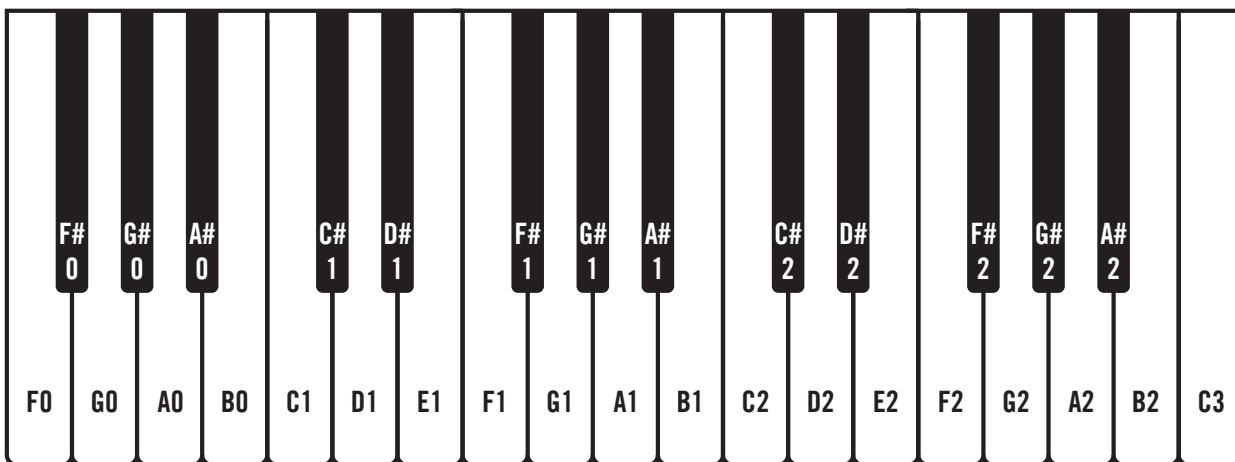

CHANGING THE MIDI CHANNEL

Grandmother can send and receive data on any MIDI channel. To select the MIDI channel, press the (**F#0**) key, and then press one of the first 16 white keys (**F0** to **G2**) to select the corresponding MIDI channel (1-16). The Default is MIDI Channel 1.

MIDI CLOCK INPUT

Grandmother's Sequencer and Arpeggiator can be set to follow MIDI Clock, and can respond to Start and Stop commands received via MIDI. Depending on your setup, you may wish for Grandmother to ignore these commands. To change this setting, press the (**G#0**) key, and then use the first three white keys to select FOLLOW MIDI CLOCK + MIDI START/STOP COMMANDS (**F0**), FOLLOW MIDI CLOCK ONLY (Ignore MIDI Start/Stop commands) (**G0**), or IGNORE ALL MIDI CLOCK + MIDI START/STOP COMMANDS (**A0**).

MIDI CLOCK OUTPUT

Grandmother's Sequencer and Arpeggiator can be set to output MIDI Clock and Start and Stop commands. Depending on your setup, you may wish for Grandmother not to send these commands. To change this setting, press the (**A#0**) key, and then use the first three white keys to select SEND MIDI CLOCK + MIDI START/STOP COMMANDS (**F0**), SEND MIDI CLOCK ONLY (Don't send MIDI Start/Stop commands) (**G0**), or DON'T SEND MIDI CLOCK OR MIDI START/STOP COMMANDS (**A0**).

GLOBAL SETTINGS *(Continued)*

NOTE PRIORITY

You can select which note will have priority on Grandmother's monophonic keyboard - the highest note played, the lowest note played, or the most recent note played. To change the note priority, press the **(C#1)** key, and then use the first three white keys to select LOW (**(FO)**), HIGH (**(GO)**), or LAST (**(AO)**). The Default is LAST.

PITCH BEND RANGE

The pitch bend range of Grandmother's **PITCH** wheel can be set anywhere from 1 to 12 semitones. To adjust the Pitch Bend Range setting, press the **(D#1)** key, and then use the lowest 12 white keys (**(FO)** to **(C2)**) to select the corresponding number of semitones (1-12). The Default is 2 semitones.

EXTERNAL CLOCK MODE

Via the real panel **CLOCK IN** jack, Grandmother can either sync to an external clock signal, or advance each time a gate or trigger signal is received. To specify the external clock mode, first press the **(F#1)** key, and then use the first two white keys to select CLOCK (**(FO)**), or STEP-ADVANCE (**(GO)**). The Default is CLOCK.

EXTERNAL CLOCK INPUT PPQN

To be sure that Grandmother's Sequencer and Arpeggiator sync correctly to an External Clock, you can determine how many pulses are received per quarter note (PPQN). To edit the PPQN value, first press the **(G#1)** key, and then use the first eight white keys to choose the number of clock pulses received per quarter note. (**(FO)** = 1 PPQN; **(GO)** = 2 PPQN; **(AO)** = 3 PPQN; **(BO)** = 4 PPQN; **(C1)** = 5 PPQN; **(D1)** = 6 PPQN; **(E1)** = 7 PPQN; **(F1)** = 8 PPQN; **(G1)** = 9 PPQN; **(A1)** = 10 PPQN; **(B1)** = 11 PPQN; **(C2)** = 12 PPQN; **(D2)** = 24 PPQN; **(E2)** = 48 PPQN. The Default is 2PPQN.

CLOCK OUTPUT PPQN

To be sure that external devices sync correctly to Grandmother's Sequencer and Arpeggiator, you can set how many pulses are sent per quarter note (PPQN). To edit the PPQN value, first press the **(A#1)** key, and then use the first eight white keys to choose the number of clock pulses sent per quarter note. (**(FO)** = 1 PPQN; **(GO)** = 2 PPQN; **(AO)** = 3 PPQN; **(BO)** = 4 PPQN; **(C1)** = 5 PPQN; **(D1)** = 6 PPQN; **(E1)** = 7 PPQN; **(F1)** = 8 PPQN; **(G1)** = 9 PPQN; **(A1)** = 10 PPQN; **(B1)** = 11 PPQN; **(C2)** = 12 PPQN; **(D2)** = 24 PPQN; **(E2)** = 48 PPQN. The Default is 2PPQN.

KB OUT RANGE

The voltage range of Grandmother's KB OUT (pitch CV) jack can be either -5 to +5 Volts, or 0 to 10 Volts. To adjust the KB OUT Range setting, press the **(C#2)** key, and then use the first two white keys to select -5V to +5V (**(FO)**), or 0V to 10V (**(GO)**). The Default is -5V to +5V.

LOCAL ON / OFF

Grandmother can be used to drive external synthesizer modules, as well as its own internal sound engine and modules. In some cases, you may wish to have Grandmother only controlling an external setup. By setting the Local parameter to OFF, Grandmother's Keyboard, **PITCH** wheel, and Arpeggiator are only transmitted through the **KB OUT**, **GATE OUT**, **KB VELOCITY OUT** jacks, and MIDI, and do not use any hard-wired connections to play the internal sound engine. To access the Local setting, first press the **(D#2)** key, and then use the lowest 2 white keys to select LOCAL OFF (**(FO)**), or LOCAL ON (**(GO)**). The Default is Local ON.

PATCH POINT INDEX FRONT PANEL

ARP / SEQ MODULE

GATE OUT: This jack produces a Gate with each new note played on the keyboard, played by the Arpeggiator, or played by the Sequencer.
5 Ohms; +8 Volt Gate.

KB OUT: This jack delivers a Control Voltage (CV) based on the key played by the Keyboard, Arpeggiator, or Sequencer.
5 Ohms; -5 to +5 Volts.

KB VEL OUT: This jack delivers a Control Voltage (CV) based on the velocity of the key played by the Keyboard or Arpeggiator. During Sequencer playback, this jack will output a control voltage envelope when steps with an Accent are played.
5 Ohms; 0 to +5 Volts.

MODULATION MODULE

RATE IN: The control signal received here is added to the value of the **RATE** knob to determine the speed of the Modulation Oscillator.
100K Ohms; -5 to +5 Volts.

SYNC IN: The rising edge of a control signal received will reset the Modulation Oscillator to its starting point.
100K Ohms; 0 to +5 Volts.

WAVE OUT: This jack outputs the selected Waveform as a control signal, at the current Rate setting.
5 Ohms; 10 Volts Peak-to-Peak (DC Coupled).

S/H OUT: This jack delivers a random Control Voltage (CV) created by sampling the value of the Noise source at each zero-crossing of the Modulation Oscillator.
2K Ohms; -5 to +5 Volts.

OSCILLATORS MODULE

OSCILLATOR 1 WAVE OUT: This jack outputs the selected Waveform as a control signal, at the current Frequency.
2K Ohms; 10 Volts Peak-to-Peak (AC Coupled).

OSCILLATOR 1 PITCH IN: The control signal received here is summed with the internal Pitch CV to modulate the pitch of the Oscillator 1.
90K Ohms; -5 to +5 Volts.

OSCILLATOR 1 PWM IN: The control signal received here can modulate the duty cycle, or pulse width, of the Square wave (50% starting duty cycle) or the Narrow Pulse wave (25% starting duty cycle).
100K Ohms; 0 to +5 Volts.

OSCILLATOR 2 WAVE OUT: This jack outputs the selected Waveform as a control signal, at the current Frequency.
2K Ohms; 10 Volts Peak-to-Peak (AC Coupled).

PATCH POINT INDEX FRONT PANEL *(Continued)*

OSCILLATORS MODULE *(Continued)*

OSCILLATOR 2 PITCH IN: The control signal received here is summed with the internal Pitch CV to modulate the pitch of Oscillator 2.
90K Ohms; -5 to +5 Volts.

OSCILLATOR 2 LIN FM IN: The control signal received here is summed with the internal Pitch CV to introduce linear FM (Frequency Modulation) to Oscillator 2.
90K Ohms; -5 to +5 Volts.

MIXER MODULE

OSC 1 IN: The audio source or control signal connected to this input will replace the normalled connection of the output of Oscillator 1 to the input of the mixer. The mixer's **OSCILLATOR 1** knob will now control the level of this new signal.
100K Ohms; -5 to +5 Volts.

OSC 2 IN: The audio source or control signal connected to this input will replace the normalled connection of the output of Oscillator 2 to the input of the mixer. The mixer's **OSCILLATOR 2** knob will now control the level of this new signal.
100K Ohms; -5 to +5 Volts.

NOISE IN: The audio source or control signal connected to this input will replace the normalled connection of the output of the Noise generator to the input of the mixer. The mixer's **NOISE** knob will now control the level of this new signal.
100K Ohms; -5 to +5 Volts.

OUTPUT (MIXER OUTPUT): The combined output of all mixer input sources is available via this output jack.
2K Ohms; output level is determined by the combined individual level knob settings.

UTILITIES MODULE

MULT JACKS: The four unbuffered **MULT** jacks can be employed either as inputs or outputs, and can accommodate audio signals or control signals. Any signal (audio or control) can be inserted into one **MULT** jack and distributed to up to three locations by using the remaining jacks as outs. In special cases, the **MULT** jacks can be used to merge up to two audio AC coupled audio sources (**OSCILLATOR 1 WAVE OUT**, **OSCILLATOR 2 WAVE OUT**, **FILTER OUT**, **HP FILTER OUT**, **WET OUT**, and the **EURORACK OUT**) and to send the merged signal to up to two destinations using the remaining two jacks.

HIGH PASS FILTER INPUT: The audio source connected to this input will be processed by the High Pass Filter.
110K Ohms; -5 to +5 Volts.

HIGH PASS FILTER OUTPUT: The output of the High Pass Filter is available via this jack.
2K Ohms; 10 Volts Peak-to-Peak (AC Coupled).

ATTENUATOR INPUT: This jack provides an input to the Inverting Attenuator.
100K Ohms; -8 to +8 Volts.

PATCH POINT INDEX FRONT PANEL *(Continued)*

UTILITES MODULE *(Continued)*

ATTENUATOR OUTPUT: The output of the Inverting Attenuator is available via this jack. *5 Ohms; the output voltage is determined by the **ATTENUATOR** knob; the 12 O'clock setting provides zero output (fully attenuated).*

FILTER (LOW PASS FILTER) MODULE

FILTER INPUT: The audio source connected to this input will be processed by the Low Pass Filter (VCF). With no connection made here, the Mixer OUTPUT signal is normalled to the input of the Low Pass Filter.

100K Ohms; -5 to +5 Volts.

FILTER OUTPUT: The output of the Low Pass Filter is available via this jack.

2K Ohms; 10 Volts Peak-to-Peak (AC Coupled).

ENV AMT IN: The control signal received here is summed with the **ENVELOPE AMT** knob, and is available to amplify, vary, or constrain the amount of effect that the **ENVELOPE AMT** knob will have on the Cutoff frequency of the Low Pass Filter.

110K Ohms; -8 to +8 Volts (DC Coupled).

CUTOFF IN: The control signal received here is summed with the **KBD TRACK** setting, the **ENVELOPE AMT** value, the **CUTOFF** knob, etc. and is used to modulate the value of the Cutoff frequency of the Low Pass Filter.

100K Ohms; -5 to +5 Volts.

ENVELOPE MODULE

TRIGGER IN: Any control signal > +1.2 Volts will act as a Trigger to start the Envelope cycle. With no connection made here, the Gate signal from the Keyboard, Arpeggiator, Sequencer, etc. is normalled to this input.

100K Ohms; 0 to +8 Volts (DC Coupled).

+ ENV OUT: The control signal created by the ADSR setting of the Envelope is available via this jack.

5 Ohms; 10 Volts Peak-to-Peak (DC Coupled).

- ENV OUT: An inverted copy of the control signal created by the ADSR settings of the Envelope is available via this jack. For example, Instead of the Attack parameter raising a particular value over time, inverse modulation values cause the Attack parameter to lower a particular value by the same amount, in the same period of time.

5 Ohms; 10 Volts Peak-to-Peak (DC Coupled).

OUTPUT MODULE

VCA AMT IN: The control signal received here will affect Grandmother's output Volume. When the **VCA TYPE** switch is set to **DRONE**, connecting a control signal here will instantly set the VCA CV to zero. The value of the control signal alone will be used to control the output volume. With the **VCA TYPE** switch set to **ENV** or **KB RLS**, the value of the control signal received via this input is summed with the current settings to set the output level.

*100K Ohms; 0 to +8 Volts (**DRONE** setting); -8 to +8 Volts (**ENV** or **KB RLS** setting.)*

PATCH POINT INDEX FRONT PANEL *(Continued)*

OUTPUT MODULE *(Continued)*

VCA IN: This jack provides an audio input to the VCA. With no connection made here, the signal from the Filter output is normalled to this input.
100K Ohms; -5 to +5 Volts.

REVERB IN: This jack provides an audio input to the Spring Reverb unit. With no connection made here, the signal from the VCA output is normalled to this input.
100K Ohms; -5 to +5 Volts.

PATCH POINT INDEX REAR PANEL

ARP / SEQ CV PANEL

CLOCK IN: The Arpeggiator and/or Sequencer will synchronize to the rising edge of a clock/control signal connected to this jack, allowing Grandmother to sync with other clocks.
100K Ohms; -5 to +5 Volts.

ON / OFF IN: A control signal connected to this jack can turn the Grandmother Arpeggiator and/or Sequencer on and off. A voltage of > 2.5 Volts will turn the ARP / SEQ module on. An incoming voltage of <2.5 Volts will turn the ARP / SEQ module off.
100K Ohms; OFF = 0 Volts / ON = +5 Volts.

RESET IN: A control signal connected to this jack can reset the Grandmother Arpeggiator and/or Sequencer to the beginning of the pattern. An incoming voltage of > 2.5 Volts will reset the ARP / SEQ module.
100K Ohms; 0 to +5 Volts.

CLOCK OUT: This output provides a clock output that can be used to drive other clock-able units to the rate of Grandmother's ARP / SEQ module.
100K Ohms; 0 to +5V Clock signal at the internal clock tempo

AUDIO OUT PANEL

EURORACK OUT: This jack provides a buffered version of the main output that is fully compatible with other Eurorack modules and systems. The output level is set after the **REVERB MIX** knob, but before the **VCA VOLUME** knob.
2K Ohms; -5 to +5 Volts (AC Coupled). Maximum levels reach -8 to +8 Volts.

REVERB OUT: The audio signal that appears at the output of the **SPRING REVERB** is available via this jack. Combined with the **REVERB** in jack on the front panel, the **SPRING REVERB** can function as independent effect unit.
1K Ohms; 10 Volts Peak-to-Peak (AC Coupled).

MIDI DOCUMENTATION

FUNCTION	CC#	
PITCH WHEEL		
MOD WHEEL	CC 1	0-127 (or 0-16383 using CC1 & CC 33)
MODULATION RATE	CC 3	0-127 (or 0-16383 using CC3 & CC 35)
GLIDE TIME	CC 5	0-127 (or 0-16383 using CC5 & CC 37)
ARP/SEQ RATE	CC 8	0-127 (or 0-16383 using CC8 & CC 40)
OSCILLATOR 2 FREQUENCY	CC 12	0-127 (or 0-16383 using CC12 & CC 44)
GLIDE ON/OFF	CC 65	0 = Off, 64 = On
ARP/SEQ HOLD	CC 69	0 = Off, 64 = On
ARP/SEQ PLAY	CC 73	0 = Off, 64 = On
OSCILLATOR 1 OCTAVE	CC 74	0 = 32', 32 = 16', 64 = 8', 96 = 4'
OSCILLATOR 2 OCTAVE	CC 75	0 = 32', 32 = 16', 64 = 8', 96 = 4'
OSCILLATOR 2 SYNC	CC 77	0 = Off, 64 = On
GLIDE TYPE	CC 85	0 = LCR, 43 = LCT, 85 = Exponential
KEYBOARD OCTAVE	CC 89	0 = -2, 26 = -1, 51 = 0, 77 = +1, 102 = +2
ARP/SEQ CLOCK DIVISION	CC 90	(See Grandmother Clock Divisions table)
ARP/SEQ MODE	CC 91	0 = ARP, 43 = SEQ, 85 = REC
ARP/SEQ PATTERN	CC 92	0 = ORDR, 43 = FWD/BKWD, 85 = RNDM
ARP RANGE/SEQ NUMBER	CC 93	0 = 1, 43 = 2, 85 = 3
LEGATO GLIDE	CC 94	0 = Off, 64 = On
GATED GLIDE	CC 103	0 = Off, 64 = On
PITCH BEND UP AMT	CC 107	(see table 2)
PITCH BEND DOWN AMT	CC 108	(see table 2)
KB TRANSPOSE (SEMITONES)	CC 119	(see table 3)

ADDITIONAL MIDI FUNCTIONS	
PITCH BEND AMOUNT	RPN 0
FINE TUNING	RPN 1
COARSE TUNING	RPN 2
SUSTAIN PEDAL	MIDI CC 64
LOCAL CONTROL ON/OFF	MIDI CC 122
ALL SOUNDS OFF / ALL NOTES OFF	RECEIVES MIDI CC 120, 123

GRANDMOTHER CLOCK DIVISIONS	CC 90 VALUE
4 WHOLE NOTES	0
3 WHOLE NOTES	5
2 WHOLE NOTES	11
DOTTED WHOLE NOTE	16
WHOLE NOTE	21
DOTTED HALF NOTE	27
WHOLE NOTE TRIPLET	32
HALF NOTE	37

CLOCK DIVISIONS <i>(Continued)</i>	CC 90 VALUES
DOTTED QUARTER NOTE	43
HALF NOTE TRIPLET	48
QUARTER NOTE	53
DOTTED EIGHTH NOTE	59
QUARTER NOTE TRIPLET	64
EIGHTH NOTE	69
DOTTED SIXTEENTH NOTE	75
EIGHTH NOTE TRIPLET	80
SIXTEENTH NOTE	85
DOTTED 32ND NOTE	91
SIXTEENTH NOTE TRIPLET	96
32ND NOTE	101
DOTTED 64TH NOTE	107
32ND NOTE TRIPLET	112
64TH NOTE	117
64TH NOTE TRIPLET	123

MIDI DOCUMENTATION *(Continued)*

TABLE 2

BEND RANGE (SEMITONES)	CC 107 / CC108 VALUE
0 (OFF)	0
1	5
2	10
3	15
4	20
5	26
6	31
7	36
8	41
9	46
10	51
11	56
12 (ONE OCTAVE)	61
13	67
14	72
15	77
16	82
17	87
18	92
19	97
20	102
21	108
22	113
23	118
24 (TWO OCTAVES)	123

TABLE 3

KEYBOARD TRANSCOPE (SEMITONES)	CC 119 VALUE
-12	0
-11	5
-10	10
-9	15
-8	20
-7	26
-6	31
-5	36
-4	41
-3	46
-2	51
-1	56
0 (OFF)	61
+1	67
+2	72
+3	77
+4	82
+5	87
+6	92
+7	97
+8	102
+9	108
+10	113
+11	118
+12	123

NOTE: Additional presets and blank patch sheets can be downloaded at www.moogmusic.com.

ARP/SEQ
 GATE OUT REVERB OUT RATE
 ARP SEQ REB
 MODE
 FWD/RWD INDIR
 DIRECTION
 1 2 3
 OCT/SEQ

MODULATION
 RATE IN SYNC IN SHROU RATE
 PITCH AMT CUTOFF AMT WAVEFORM
 PULSE WIDTH AMT WAVEFORM

OSCILLATORS
 1 2
 WAVE OUT WAVE OUT
 PITCH IN PWMIN LIN FWH IN
 PITCH IN LIN FWH IN
 OCTAVE OCTAVE
 32 16 8 4 2
 SYNC WAVEFORM WAVEFORM
 16 8 4 2

MIXER
 OSC 1 IN OSC 2 IN
 NOISE IN OUTPUT
 OSCILLATOR 1 OSCILLATOR 2 NOISE

UTILITIES
 MULT HIGH PASS ATTENUATOR
 INPUT OUTPUT INPUT OUTPUT

FILTER
 INPUT ENVELOPE AMT CUTOFF IN 2000Hz
 CUTOFF 200Hz
 RESONANCE
 ENVELOPE AMT
 0 1:1
 1:2

ENVELOPE
 TRIGGER IN +ENVELOPE ENVELOPE
 ATTACK DECAY RELEASE SUSTAIN

OUTPUT
 VCA AMT IN VCA IN REVERB IN
 VOLUME
 ENV. AR.DS. VCA MODE
 SPRING REVERB MIX

• Mod wheel up adds a robot voice

FUNKY ROBOT

ARP/SEQ
 GATE OUT REVERB OUT RATE
 ARP SEQ REB
 MODE
 FWD/RWD INDIR
 DIRECTION
 1 2 3
 OCT/SEQ

MODULATION
 RATE IN SYNC IN SHROU RATE
 PITCH AMT CUTOFF AMT WAVEFORM
 PULSE WIDTH AMT WAVEFORM

OSCILLATORS
 1 2
 WAVE OUT WAVE OUT
 PITCH IN PWMIN LIN FWH IN
 PITCH IN LIN FWH IN
 OCTAVE OCTAVE
 32 16 8 4 2
 SYNC WAVEFORM WAVEFORM
 16 8 4 2

MIXER
 OSC 1 IN OSC 2 IN
 NOISE IN OUTPUT
 OSCILLATOR 1 OSCILLATOR 2 NOISE

UTILITIES
 MULT HIGH PASS ATTENUATOR
 INPUT OUTPUT INPUT OUTPUT

FILTER
 INPUT ENVELOPE AMT CUTOFF IN 2000Hz
 CUTOFF 200Hz
 RESONANCE
 ENVELOPE AMT
 0 1:1
 1:2

ENVELOPE
 TRIGGER IN +ENVELOPE ENVELOPE
 ATTACK DECAY RELEASE SUSTAIN

OUTPUT
 VCA AMT IN VCA IN REVERB IN
 VOLUME
 ENV. AR.DS. VCA MODE
 SPRING REVERB MIX

• Mod Wheel adds more motion
• Attenuator controls the tremolo amount

SHOWDOWN GUITAR

DYNASTY PLUCKS

HAUNTED CAVE

ARP/SEQ

GATE OUT
 REVERSE OUT
 RATE
 ARP SEQ REB
 NODE
 FWD/REVW DIRECTION
 1 2 3
 OCT/SEQ

MODULATION

RATE IN
 SYNC IN
 RATE
 PITCH AMT
 CUTOFF AMT
 WAVEFORM
 PULSE WIDTH AMT

OSCILLATORS

WAVE OUT
 PITCH IN
 PW IN
 16° 8° 4°
 OCTAVE
 SYNC
 WAVEFORM
 2
 WAVE OUT
 PITCH IN
 LIN IN
 16° 8° 4° 2°
 OCTAVE
 FREQUENCY
 WAVEFORM

MIXER

OSC 1 IN
 OSC 2 IN
 NOISE IN
 OSCILLATOR 1
 OSCILLATOR 2
 NOISE

UTILITIES

INPUT
 MULT
 HIGH PASS
 ATTENUATOR
 INPUT
 OUTPUT

FILTER

INPUT
 ENV AMT IN
 CUTOFF IN
 2000Hz
 200Hz
 CUTOFF
 1:2 OFF 1:1
 RBD TRACK
 ENV AMT
 RESONANCE
 ENVELOPE AMT

ENVELOPE

TRIGGER IN
 +ENV OUT
 ENV OUT
 ATTACK
 DECAY
 RELEASE
 SUSTAIN

OUTPUT

VCA AMT IN
 VCA IN
 REVERB IN
 VOLUME
 ENV GLESS PHONE
 VCA MODE
 SPRING REVERB
 MIX

DYNASTY PLUCKS

HAUNTED CAVE

ARP/SEQ

GATE OUT
 REVERSE OUT
 RATE
 ARP SEQ REB
 NODE
 FWD/REVW DIRECTION
 1 2 3
 OCT/SEQ

MODULATION

RATE IN
 SYNC IN
 RATE
 PITCH AMT
 CUTOFF AMT
 WAVEFORM
 PULSE WIDTH AMT

OSCILLATORS

WAVE OUT
 PITCH IN
 PW IN
 16° 8° 4°
 OCTAVE
 SYNC
 WAVEFORM
 2
 WAVE OUT
 PITCH IN
 LIN IN
 16° 8° 4° 2°
 OCTAVE
 FREQUENCY
 WAVEFORM

MIXER

OSC 1 IN
 OSC 2 IN
 NOISE IN
 OSCILLATOR 1
 OSCILLATOR 2
 NOISE

UTILITIES

INPUT
 MULT
 HIGH PASS
 ATTENUATOR
 INPUT
 OUTPUT

FILTER

INPUT
 ENV AMT IN
 CUTOFF IN
 2000Hz
 200Hz
 CUTOFF
 1:2 OFF 1:1
 RBD TRACK
 ENV AMT
 RESONANCE
 ENVELOPE AMT

ENVELOPE

TRIGGER IN
 +ENV OUT
 ENV OUT
 ATTACK
 DECAY
 RELEASE
 SUSTAIN

OUTPUT

VCA AMT IN
 VCA IN
 REVERB IN
 VOLUME
 ENV GLESS PHONE
 VCA MODE
 SPRING REVERB
 MIX

ULTRA SUB BASS

• Mod wheel adds gentle motion

ARP/SEQ

GATE OUT REVERSE OUT RATE

ARP SEQ REB NODE

ORBIT/FWD/RWID/INOM DIRECTION

OCT/SEQ 1 2 3

MODULATION

RATE IN SYNC IN RATE

PITCH AMT CUTOFF AMT

PULSE WIDTH AMT

OSCILLATORS

1 2

WAVE OUT

PITCH IN PW IN OCTAVE

PITCH IN LIN IN OCTAVE

SYNC

FREQUENCY

WAVEFORM

MIXER

OSC 1 IN OSC 2 IN

NOISE IN

OSCILLATOR 1 OSCILLATOR 2

NOISE

UTILITIES

MULT

HIGH PASS

ATTENUATOR

FILTER

INPUT

ENV AMT IN CUTOFF IN

2000Hz 200Hz 20kHz

CUTOFF

OFF 1:1

12 ABD TRACK

ENVELOPE AMT RESONANCE

ENVELOPE

TRIGGER IN

ENV OUT

ATTACK

DECAY

RELEASE

SUSTAIN

OUTPUT

VCA AMT IN

VCA IN REVERB IN

VOLUME

ENV 12 ABD TRACK

VCA MODE

SPRING REVERB MIX

CAVERN STRINGS

ARP/SEQ

GATE OUT REVERSE OUT RATE

ARP SEQ REB NODE

ORBIT/FWD/RWID/INOM DIRECTION

OCT/SEQ 1 2 3

MODULATION

RATE IN SYNC IN RATE

PITCH AMT CUTOFF AMT

PULSE WIDTH AMT

OSCILLATORS

1 2

WAVE OUT

PITCH IN PW IN OCTAVE

PITCH IN LIN IN OCTAVE

SYNC

FREQUENCY

WAVEFORM

MIXER

OSC 1 IN OSC 2 IN

NOISE IN

OSCILLATOR 1 OSCILLATOR 2

NOISE

UTILITIES

MULT

HIGH PASS

ATTENUATOR

FILTER

INPUT

ENV AMT IN CUTOFF IN

2000Hz 200Hz 20kHz

CUTOFF

OFF 1:1

12 ABD TRACK

ENVELOPE AMT RESONANCE

ENVELOPE

TRIGGER IN

ENV OUT

ATTACK

DECAY

RELEASE

SUSTAIN

OUTPUT

VCA AMT IN

VCA IN REVERB IN

VOLUME

ENV 12 ABD TRACK

VCA MODE

SPRING REVERB MIX

J-BASS

ARP/SEQ

RATE
 KEYS OUT
 GATE OUT
 VCA AMT IN
 REVERB IN
 VCA MODE
 ENV. IR BLS. BDRNE
 VCA MODE
 SPRING REVERB
 MIX

MODULATION

RATE
 SYNC IN
 SPLIT OUT
 WAVE OUT
 PITCH AMT
 CUTOFF AMT
 WAVEFORM
 PULSE WIDTH AMT

OSCILLATORS

1
 PITCH IN
 PW IN
 WAVE OUT
 16° 8° 4°
 OCTAVE
 SYNC
 WAVEFORM
 2
 PITCH IN
 LIN IN
 WAVE OUT
 16° 8° 4° 2°
 OCTAVE
 FREQUENCY
 WAVEFORM

MIXER

OSC 1 IN
 OSC 2 IN
 NOISE IN
 OSCILLATOR 1
 OSCILLATOR 2
 NOISE
 INPUT
 HIGH PASS
 ATTENUATOR
 OUTPUT

UTILITIES

MULT
 INPUT
 HIGH PASS
 ATTENUATOR
 OUTPUT

FILTER

PUT
 ENV AMT IN
 CUTOFF IN
 200Hz
 2kHz
 20kHz
 CUTOFF
 1:2 OFF 1:1
 KBD TRACK
 ENV AMT
 RESONANCE
 ENVELOPE AMT

ENVELOPE

TRIGGER IN
 ENV OUT
 ATTACK
 DECAY
 RELEASE
 SUSTAIN

OUTPUT

VCA AMT IN
 REVERB IN
 VOLUME
 ENV. IR BLS. BDRNE
 VCA MODE
 SPRING REVERB
 MIX

AUTO ZAP BASS

ARP/SEQ

RATE
 KEYS OUT
 GATE OUT
 VCA AMT IN
 REVERB IN
 VCA MODE
 ENV. IR BLS. BDRNE
 VCA MODE
 SPRING REVERB
 MIX

MODULATION

RATE
 SYNC IN
 SPLIT OUT
 WAVE OUT
 PITCH AMT
 CUTOFF AMT
 WAVEFORM
 PULSE WIDTH AMT

OSCILLATORS

1
 PITCH IN
 PW IN
 WAVE OUT
 16° 8° 4°
 OCTAVE
 SYNC
 WAVEFORM
 2
 PITCH IN
 LIN IN
 WAVE OUT
 16° 8° 4° 2°
 OCTAVE
 FREQUENCY
 WAVEFORM

MIXER

OSC 1 IN
 OSC 2 IN
 NOISE IN
 OSCILLATOR 1
 OSCILLATOR 2
 NOISE
 INPUT
 HIGH PASS
 ATTENUATOR
 OUTPUT

UTILITIES

MULT
 INPUT
 HIGH PASS
 ATTENUATOR
 OUTPUT

FILTER

INPUT
 ENV AMT IN
 CUTOFF IN
 200Hz
 2kHz
 20kHz
 CUTOFF
 1:2 OFF 1:1
 KBD TRACK
 ENV AMT
 RESONANCE
 ENVELOPE AMT

ENVELOPE

TRIGGER IN
 ENV OUT
 ATTACK
 DECAY
 RELEASE
 SUSTAIN

OUTPUT

VCA AMT IN
 REVERB IN
 VOLUME
 ENV. IR BLS. BDRNE
 VCA MODE
 SPRING REVERB
 MIX

STEPPED DRONE

• Mod wheel up!

ARP/SEQ
 KBD OUT, GATE OUT, RATE, ARP SEQ MODE, ON/OFF, ENV/BRND, RNDM, DIRECTION, 1 2 3 OCT / SEQ

MODULATION
 RATE IN, SYNC IN, RATE, SYNC, PITCH AMT, CUTOFF AMT, WAVEFORM, PULSE WIDTH AMT

OSCILLATORS
 1: WAVE OUT, PITCH IN, PITCH IN, 32, 8, 4, OCTAVE, SYNC, WAVEFORM, 2: WAVE OUT, LIN FREQ IN, LIN FREQ IN, 16, 8, 4, 2, OCTAVE, FREQUENCY, WAVEFORM

MIXER
 OSC 1 IN, OSC 2 IN, NOISE IN, OSCILLATOR 1, OSCILLATOR 2, NOISE

UTILITIES
 INPUT, MULT, HIGH PASS, ATTENUATOR, OUTPUT

FILTER
 INPUT, ENVELOPE AMT, ENVELOPE AMT, 200Hz, 200Hz, 200Hz, CUTOFF, 1:2 OFF, 1:1, KBD TRACK, RESONANCE, ENVELOPE AMT

ENVELOPE
 TRIGGER IN, ENVELOPE AMT, ATTACK, DECAY, RELEASE, SUSTAIN

OUTPUT
 VCA AMT IN, VCA IN, REVERB IN, VOLUME, ENV, KBD, BRND, VCA MODE, SPRING REVERB, MIX

CYCLICAL PATTERNS

ARP/SEQ
 KBD OUT, GATE OUT, RATE, ARP SEQ MODE, ON/OFF, ENV/BRND, RNDM, DIRECTION, 1 2 3 OCT / SEQ

MODULATION
 RATE IN, SYNC IN, RATE, SYNC, PITCH AMT, CUTOFF AMT, WAVEFORM, PULSE WIDTH AMT

OSCILLATORS
 1: WAVE OUT, PITCH IN, PITCH IN, 32, 8, 4, OCTAVE, SYNC, WAVEFORM, 2: WAVE OUT, LIN FREQ IN, LIN FREQ IN, 16, 8, 4, 2, OCTAVE, FREQUENCY, WAVEFORM

MIXER
 OSC 1 IN, OSC 2 IN, NOISE IN, OSCILLATOR 1, OSCILLATOR 2, NOISE

UTILITIES
 INPUT, MULT, HIGH PASS, ATTENUATOR, OUTPUT

FILTER
 INPUT, ENVELOPE AMT, ENVELOPE AMT, 200Hz, 200Hz, 200Hz, CUTOFF, 1:2 OFF, 1:1, KBD TRACK, RESONANCE, ENVELOPE AMT

ENVELOPE
 TRIGGER IN, ENVELOPE AMT, ATTACK, DECAY, RELEASE, SUSTAIN

OUTPUT
 VCA AMT IN, VCA IN, REVERB IN, VOLUME, ENV, KBD, BRND, VCA MODE, SPRING REVERB, MIX

BAG PIPES

ARP/SEQ

BLEND OUT

BLEND IN

BLEND IN

RATE

ARP SEQ REE
MODE

DIR: FWD/REV
DIRECTION

1 2 3
OCT/SEQ

MODULATION

WAVE OUT

RATE IN

SYNC IN

SRCH OUT

RATE

PITCH AMT

CUTOFF AMT

WAVEFORM

PULSE WIDTH AMT

OSCILLATORS

1

WAVE OUT

PITCH IN

PW IN

16" 8" 4" 2"

OCTAVE

SYNC

WAVEFORM

2

WAVE OUT

PITCH IN

LIN FM IN

16" 8" 4" 2"

OCTAVE

FREQUENCY

WAVEFORM

MIXER

OSC 1 IN

OSC 2 IN

NOISE IN

OSCILLATOR 1

OSCILLATOR 2

NOISE

UTILITIES

INPUT

MULT

HIGH PASS

INPUT

ATTENUATOR

OUTPUT

FILTER

INPUT

EW AMT IN

CUTOFF IN

200Hz

2kHz

20kHz

CUTOFF

1:2 OFF (T)

1:1

KBD TRACK

ENVELOPE AMT

RESONANCE

ENVELOPE

TRIGGER IN

ENV OUT

ENV OUT

ATTACK

DECAY

RELEASE

SUSTAIN

OUTPUT

VCA AMT IN

VCA IN

REVERB IN

VOLUME

ENV (REV) DIR

MODE

VCA MODE

SPRING REVERB

MIX

PIANO BASS

ARP/SEQ

BLEND OUT

BLEND IN

BLEND IN

RATE

ARP SEQ REE
MODE

DIR: FWD/REV
DIRECTION

1 2 3
OCT/SEQ

MODULATION

WAVE OUT

RATE IN

SYNC IN

SRCH OUT

RATE

PITCH AMT

CUTOFF AMT

WAVEFORM

PULSE WIDTH AMT

OSCILLATORS

1

WAVE OUT

PITCH IN

PW IN

16" 8" 4" 2"

OCTAVE

SYNC

WAVEFORM

2

WAVE OUT

PITCH IN

LIN FM IN

16" 8" 4" 2"

OCTAVE

FREQUENCY

WAVEFORM

MIXER

OSC 1 IN

OSC 2 IN

NOISE IN

OSCILLATOR 1

OSCILLATOR 2

NOISE

UTILITIES

INPUT

MULT

HIGH PASS

INPUT

ATTENUATOR

OUTPUT

FILTER

INPUT

EW AMT IN

CUTOFF IN

200Hz

2kHz

20kHz

CUTOFF

1:2 OFF (T)

1:1

KBD TRACK

ENVELOPE AMT

RESONANCE

ENVELOPE

TRIGGER IN

ENV OUT

ENV OUT

ATTACK

DECAY

RELEASE

SUSTAIN

OUTPUT

VCA AMT IN

VCA IN

REVERB IN

VOLUME

ENV (REV) DIR

MODE

VCA MODE

SPRING REVERB

MIX

ARP/SEQ
 GATE OUT REVERSE OUT RATE
 REOUT REVERSE IN
 ARP SEQ REE
 NODE
 FWD/RWD IN/DIR
 DIRECTION
 1 2 3
 OCT/SEQ

MODULATION
 RATE IN SYNC IN RATE
 SYNC IN SYNC OUT
 RATE
 PITCH AMT CUTOFF AMT
 PULSE WIDTH AMT

OSCILLATORS
 1 WAVE OUT PITCH IN PW IN 16° 8° 4° OCTAVE
 2 WAVE OUT PITCH IN LW IN 16° 8° 4° OCTAVE
 SYNC FREQ WAVEFORM

MIXER
 OSC 1 IN OSC 2 IN NOISE IN
 OSCILLATOR 1 OSCILLATOR 2 NOISE

UTILITIES
 MULT HIGH PASS ATTEN IN ATTEN OUT

FILTER
 INPUT ENV AMT IN CUTOFF IN 2000Hz 200Hz 20kHz
 CUTOFF 1:2 OFF 1:1
 KBD TRACK
 ENV AMT ENVELOPE AMT RESONANCE

ENVELOPE
 TRIGGER IN +ENV OUT ENV OUT
 ATTACK DECAY RELEASE SUSTAIN

OUTPUT
 VCA AMT IN VCA IN REVERB IN
 VOLUME
 REVERB IN REVERB OUT
 VCA MODE

SPRING REVERB
 MIX

LIFT OFF

ARP/SEQ
 GATE OUT REVERSE OUT RATE
 REOUT REVERSE IN
 ARP SEQ REE
 NODE
 FWD/RWD IN/DIR
 DIRECTION
 1 2 3
 OCT/SEQ

MODULATION
 RATE IN SYNC IN RATE
 SYNC IN SYNC OUT
 RATE
 PITCH AMT CUTOFF AMT
 PULSE WIDTH AMT

OSCILLATORS
 1 WAVE OUT PITCH IN PW IN 16° 8° 4° OCTAVE
 2 WAVE OUT PITCH IN LW IN 16° 8° 4° OCTAVE
 SYNC FREQ WAVEFORM

MIXER
 OSC 1 IN OSC 2 IN NOISE IN
 OSCILLATOR 1 OSCILLATOR 2 NOISE

UTILITIES
 MULT HIGH PASS ATTEN IN ATTEN OUT

FILTER
 INPUT ENV AMT IN CUTOFF IN 2000Hz 200Hz 20kHz
 CUTOFF 1:2 OFF 1:1
 KBD TRACK
 ENV AMT ENVELOPE AMT RESONANCE

ENVELOPE
 TRIGGER IN +ENV OUT ENV OUT
 ATTACK DECAY RELEASE SUSTAIN

OUTPUT
 VCA AMT IN VCA IN REVERB IN
 VOLUME
 REVERB IN REVERB OUT
 VCA MODE

SPRING REVERB
 MIX

3 SAWS

ARP/SEQ

RATE IN RATE OUT
 RATE IN RATE OUT

RATE

ARP SEQ MODE
 ORDR FWD/RWD/NDM
 DIRECTION

1
 2
 3
OCY/SEQ

MODULATION

RATE IN RATE OUT
 SYNC IN SYNC OUT

RATE

PITCH AMT
 CUTOFF AMT
 PULSE WIDTH AMT

WAVEFORM

OSCILLATORS

WAVE OUT WAVE OUT
 PITCH IN PITCH IN
 PW IN PW IN

32° 16° 8° 4°
OCTAVE

16° 8° 4° 2°
OCTAVE

0
FREQUENCY

WAVEFORM
 WAVEFORM

MIXER

OSC 1 IN OSC 2 IN
 NOISE IN NOISE IN

OSCILLATOR 1

OSCILLATOR 2

NOISE

UTILITIES

INPUT INPUT
 OUTPUT OUTPUT

MULT

HIGH PASS

ATTENUATOR

FILTER

INPUT INPUT
 ENV AMT IN ENV AMT IN
 CUTOFF IN CUTOFF IN

200Hz
 2kHz
 20kHz
CUTOFF

1:2 OFF 1:1
KBD TRACK

0
ENVELOPE AMT

RESONANCE

ENVELOPE AMT

ENVELOPE

TRIGGER IN TRIGGER IN
 ENV OUT ENV OUT

ATTACK

DECAY

RELEASE

SUSTAIN

OUTPUT

VCA AMT IN VCA AMT IN
 REVERB IN REVERB IN

VOLUME

ENV
 KBD SEQ
 DRONE
VCA MODE

SPRING REVERB

MIX

ARP/SEQ

RATE IN RATE OUT
 RATE IN RATE OUT

RATE

ARP SEQ MODE
 ORDR FWD/RWD/NDM
 DIRECTION

1
 2
 3
OCY/SEQ

MODULATION

RATE IN RATE OUT
 SYNC IN SYNC OUT

RATE

PITCH AMT
 CUTOFF AMT
 PULSE WIDTH AMT

WAVEFORM

OSCILLATORS

WAVE OUT WAVE OUT
 PITCH IN PITCH IN
 PW IN PW IN

32° 16° 8° 4°
OCTAVE

16° 8° 4° 2°
OCTAVE

0
FREQUENCY

WAVEFORM
 WAVEFORM

MIXER

OSC 1 IN OSC 2 IN
 NOISE IN NOISE IN

OSCILLATOR 1

OSCILLATOR 2

NOISE

UTILITIES

INPUT INPUT
 OUTPUT OUTPUT

MULT

HIGH PASS

ATTENUATOR

FILTER

INPUT INPUT
 ENV AMT IN ENV AMT IN
 CUTOFF IN CUTOFF IN

200Hz
 2kHz
 20kHz
CUTOFF

1:2 OFF 1:1
KBD TRACK

0
ENVELOPE AMT

RESONANCE

ENVELOPE AMT

ENVELOPE

TRIGGER IN TRIGGER IN
 ENV OUT ENV OUT

ATTACK

DECAY

RELEASE

SUSTAIN

OUTPUT

VCA AMT IN VCA AMT IN
 REVERB IN REVERB IN

VOLUME

ENV
 KBD SEQ
 DRONE
VCA MODE

SPRING REVERB

MIX

ARP/SEQ

GATE OUT REVERSE OUT RATE

APP SEQ MODE

ORDR FWD/RWD INDIRM DIRECTION

1 2 3 OCT/SEQ

MODULATION

RATE IN SYNC IN RATE

PITCH AMT CUTOFF AMT

PULSE WIDTH AMT

OSCILLATORS

1

WAVE OUT PITCH IN PW IN 16° 8° 4°

2

WAVE OUT PITCH IN LIN IN 16° 4° 2°

OCTAVE

FREQUENCY

WAVEFORM

WAVEFORM

SYNC

MIXER

OSC 1 IN OSC 2 IN NOISE IN

OSCILLATOR 1 OSCILLATOR 2 NOISE

UTILITIES

MULT

HIGH PASS

ATTENUATOR

FILTER

INPUT ENV AMT IN CUTOFF IN

2000Hz 200Hz 20kHz

CUTOFF

1:2 OFF 1:1 KBD TRACK

ENV AMT

RESONANCE

ENVELOPE

TRIGGER IN

ENV OUT

ATTACK DECAY RELEASE

SUSTAIN

OUTPUT

VCA AMT IN REVERB IN

VOLUME

ENV. MODE PHONE VCA MODE

SPRING REVERB

MIX

ARP/SEQ

GATE OUT REVERSE OUT RATE

APP SEQ MODE

ORDR FWD/RWD INDIRM DIRECTION

1 2 3 OCT/SEQ

MODULATION

RATE IN SYNC IN RATE

PITCH AMT CUTOFF AMT

PULSE WIDTH AMT

OSCILLATORS

1

WAVE OUT PITCH IN PW IN 16° 8° 4°

2

WAVE OUT PITCH IN LIN IN 16° 4° 2°

OCTAVE

FREQUENCY

WAVEFORM

WAVEFORM

SYNC

MIXER

OSC 1 IN OSC 2 IN NOISE IN

OSCILLATOR 1 OSCILLATOR 2 NOISE

UTILITIES

MULT

HIGH PASS

ATTENUATOR

FILTER

INPUT ENV AMT IN CUTOFF IN

2000Hz 200Hz 20kHz

CUTOFF

1:2 OFF 1:1 KBD TRACK

ENV AMT

RESONANCE

ENVELOPE

TRIGGER IN

ENV OUT

ATTACK DECAY RELEASE

SUSTAIN

OUTPUT

VCA AMT IN REVERB IN

VOLUME

ENV. MODE PHONE VCA MODE

SPRING REVERB

MIX

SPECIFICATIONS

TYPE: Semi-Modular Analog Synthesizer

SOUND ENGINE: Analog

NUMBER OF KEYS: 32 Full-Size Keys

TYPE OF KEYS: Velocity-sensing (Velocity signal is not hard-wired – available via MIDI and **KBD VEL OUT** jack)

OTHER CONTROLLERS: Pitch Bend, Mod Wheel, Variable Glide

POLYPHONY: Monophonic

SOUND SOURCES: 2 Oscillators with selectable Waveforms (Oscillator 2 supports Sync to Oscillator 1 plus linear FM), 1 White Noise Generator, External Input jack

VCF FILTER (LOW PASS): -24dB/Octave Moog Ladder Filter with Resonance (Self-Oscillating)

STATIC FILTER (HIGH PASS): -6dB/Octave

MOD SOURCES: Modulation Oscillator (Sine, Sawtooth, Ramp, Square), S/H Output, plus Envelope and Key Tracking

ENVELOPE: Four-Stage (ADSR)

ATTENUATOR: Bipolar

MULT: Four Parallel-wired Non-buffered Patch Points

EFFECTS: Spring Reverb

ARPEGGIATOR / STEP SEQUENCER: (256 Steps; three Sequence Files)

PATCH POINTS:

41 x 3.5mm front and rear panels

21 Inputs

16 Outputs

4 Parallel-wired Mults.

AUDIO INPUT: One 1/4" TS jack (Rear Panel)

AUDIO OUTPUT: One 1/4" TRS jack for headphones or line level output (Rear Panel)

WARNING: Use a TS instrument cable for line output applications. Do not use a TRS (balanced) cable, or phase cancellation may cause a very weak signal.

MIDI I/O: 5-pin DIN In, Out, Thru; plus MIDI over USB (Rear Panel)

DIMS: 23" (54.82cm) Wide x 14 1/4" (36.19cm) Deep x 5 1/2" (13.97cm) High

POWER: Included Power Adapter 12V DC (positive tip), 2A, 100 to 240 Volts AC, 50/60Hz

WEIGHT: 16lbs. / 7.25kg

SERVICE & SUPPORT INFORMATION

MOOG'S STANDARD WARRANTY

Moog warrants its products to be free of defects in materials or workmanship and conforming to specifications at the time of shipment. The Warranty Period is one year from the date of purchase. If, in Moog's determination, it has been more than five years since the product shipped from our factory, it will be at Moog's discretion whether or not to honor the warranty without regard to the date of the purchase. During the Warranty Period, any defective products will be repaired or replaced, at Moog's option, on a return-to-factory basis. This warranty covers defects that Moog determines are no fault of the user.

The Moog Limited Warranty applies to USA purchasers only. Outside the USA the warranty policy and associated service is determined by the laws of the country of purchase and supported by our local authorized distributor. A listing of our authorized distributors is available at moogmusic.com.

If you purchase outside of your country, you can expect to be charged for warranty as well as non-warranty service by the service center in your country.

RETURNING YOUR PRODUCT TO MOOG MUSIC

You must obtain prior approval in the form of an RMA (Return Material Authorization) number from Moog before returning any product. Email techsupport@moogmusic.com for the RMA number via email or call us at (828) 251-0090. All products must be packed carefully and shipped with the Moog supplied power adapter. The Grandmother must be returned in the original inner packing including the cardboard inserts. Sorry, the warranty will not be honored if the product is not properly packed. Once you have received the RMA# and carefully packed your Moog, ship the product to Moog Music Inc. with transportation and insurance charges paid, and be sure to include your return shipping address.

MOOG MUSIC

160 Broadway St.
Asheville NC, 28801

WHAT WE WILL DO

Once received, we will examine the product for any obvious signs of user abuse or damage as a result of transport. If the product abused, damaged in transit, or is out of warranty, we will contact you with an estimate of the repair cost. Warranty work will be performed and Moog will ship and insure your product to your United States address free of charge.

HOW TO INITIATE YOUR WARRANTY

Please initiate your warranty online at www.moogmusic.com/register. If you do not have web access, please call (828) 251-0090 to register your product.

CARING FOR GRANDMOTHER

Clean the Grandmother with a soft, dry cloth only – do not use solvents or abrasive detergents. Heed the safety warnings at the beginning of the manual. Do not drop the unit.

AN IMPORTANT NOTE ABOUT SAFETY: *There are no user serviceable parts in Grandmother. Refer all servicing to qualified personnel only.*

©2018 MOOG MUSIC INC. | 160 Broadway St. Asheville, NC 28801

Moog is registered in U.S. Patent and Trademark Office

Moog (stylized with design) is registered in U.S. Patent and Trademark Office

The Moog Icon is registered in U.S. Patent and Trademark Office

Grandmother is a trademark of Moog Music Inc.

All rights reserved to Moog Music Inc. on all text and graphics here within.

Phone: 828.251.0090 | Email: info@moogmusic.com | Website: www.moogmusic.com

